

# VÄLIJOHDOT

kaksoissuojatut hyväksytyt antennijohdot  
100 % suojaus



Pakkaamme kaikki väljohdot  
kuplapakkausiin



Kuvaus	Tilaus numero	Pituus	Kuvaus
	TT1081	1m	 jatko/pistoke suorat liittimet
	TT1082	2m	
	TT1084	4m	
	TT1086	6m	
	TT1087	7m	
	TT10810	10m	
	TT10815	15m	
	TT1091	1m	 jatko/pistoke suorat liittimet +adapteri
	TT1092	2m	
	TT1094	4m	
	TT1096	6m	
	TT1097	7m	
	TT10910	10m	
	TT10915	15m	
	TT1072	2m	jatko/pistoke suorat liittimet + interferenssi suojaus (ferriitti)
	TT1074	4m	
	TT1077	7m	
	TT10710	10m	
	TT1032	2m	 F jatko/pistoke suorat liittimet +adapteri
	TT1034	4m	
	TT1037	7m	
	TT10310	10m	

Hyväksyminen



# VÄLIJOHDOT

## AV - VÄLIJOHDOT

Tasker-sarjan SCART-johdoissa on käytetty korkealaatuisia kaapeleita jotka takaavat parhaan mahdollisen kuvan ja äänentoiston.

**Ääni, Video, Data ja RGB ovat kaikki erikseen suojattuja, lisäksi Videokaapelit ovat 75-ohmisia.**

**VR35** 1,5 m 21 nap scartpistoke 21 nap scartpistoke  
**VR355** 5 m

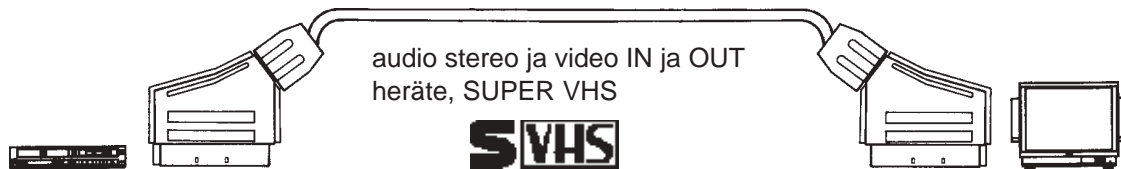

**VR99** 1,5 m 21 nap scartpistoke 21 nap scartpistoke

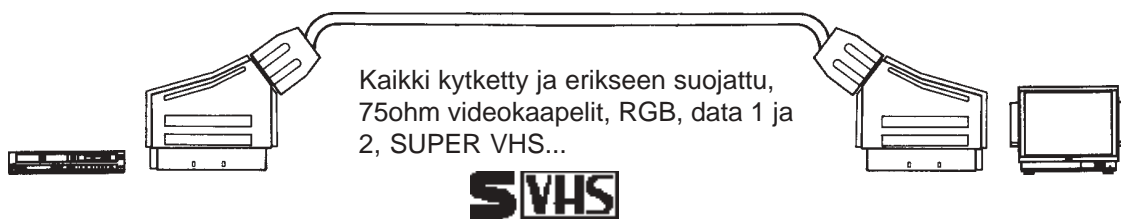

**9 AGU-** sarjan scart-johdoissa on käytetty moninapakaapeleita, joissa on erillissuojaus ja video IN/OUT on 75 Ω coax-kaapeli ja kullatut liittimet

**G625** 1,5m 21 nap kullattu scartpistoke 21 nap kullattu scartpistoke

**AGU-sarja**

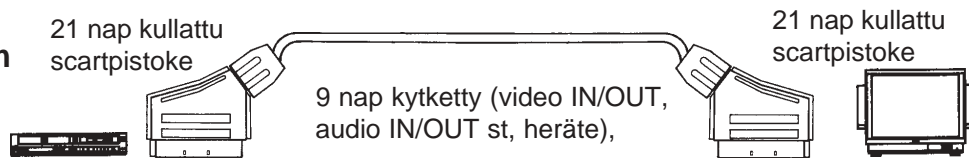

**21 AGU-** sarjan scart-johdoissa on käytetty moninapakaapeleita, joissa on erillissuojaus ja video IN/OUT on 75 Ω coax-kaapeli ja kullatut liittimet

**G799** 1,5m 21 nap kullattu scartpistoke 21 nap kullattu scartpistoke  
**G7993** 3m  
**G7995** 5m

**AGU-sarja**

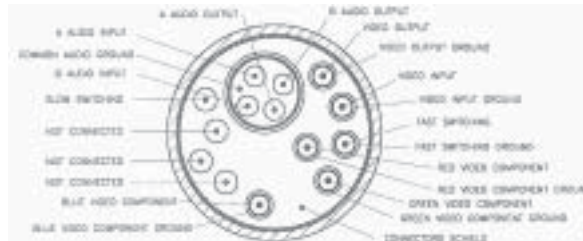

# VÄLIJOHDOT

## SCART-JOHDOT

**21 ECO** - sarjan scart-kaapeleissa on käytetty moninapakaapelia jossa on yksi yhteinen foliosuoja.

**LK799K**  
1,5 m



**9 LOOKCABLE** sarjan scart-johdoissa on käytetty moninapakaapeleita, joissa on erillissuojaus ja video IN/OUT on 75 Ω coax-kaapeli

**LK625**  
**LK6253**  
**LK6255**

1,5m  
3m  
5m

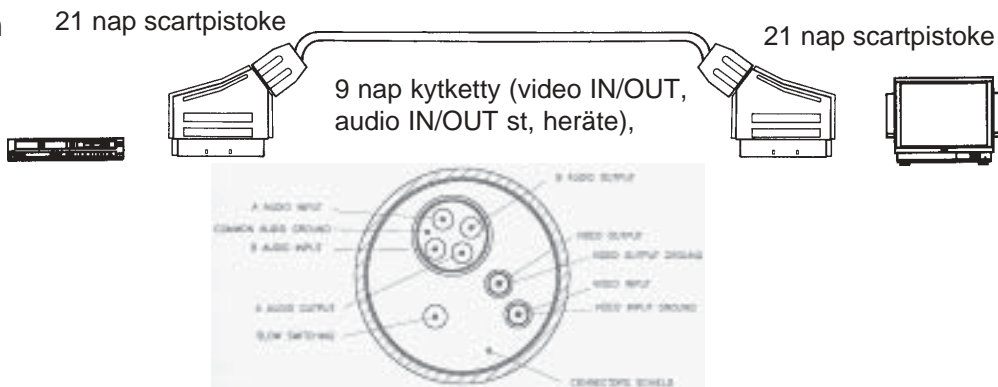

**21 LOOKCABLE** sarjan scart-johdoissa on käytetty moninapakaapeleita, joissa on erillissuojaus ja video IN/OUT on 75 Ω coax-kaapeli

**LK79905**  
**LK799**  
**LK7993**  
**LK7995**

0,5m  
1,5m  
3m  
5m



# VÄLIJOHDOT

## HIGH END AV-johdot, kullatut liittimet

**GT63** 1,5 m

lukkiutuvat RCA-pistokkeet  
foliosuojattu, balanssoitu kaapeli

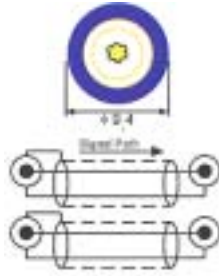

**GT82** 1,5 m

taipuisa RCA kaapeli

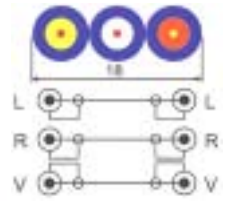

**GT66** 1,5 m

taipuisa SUPER-VHS kaapeli  
MiniDIN pistokkeet

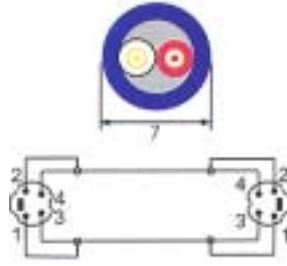

**GT78** 1,5 m

taipuisa RCA kaapeli

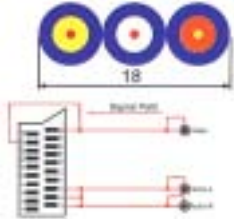

**GT200** 1,5 m

taipuisa kaapeli  
3,5 stereo plugi/  
2 RCA pistoketta

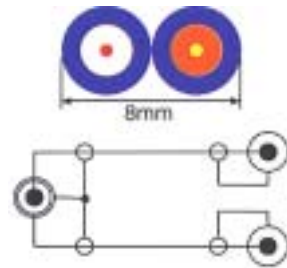

**GT41** 1,5 m

taipuisa RCA kaapeli

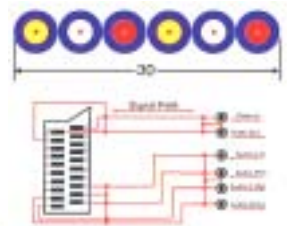

**GT23** 1,5 m

taipuisa RCA kaapeli

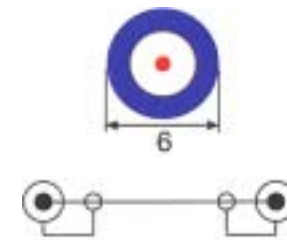

**GT68** 1,5 m

taipuisa RCA kaapeli



**GT124** 1,5 m

taipuisa RCA kaapeli

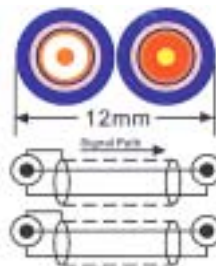

# VÄLIJOHDOT

## HIGH END AV-johdot, kullatut liittimet

GT625S 1,5 m  
GT6253S 3 m

9-napainen, suojattu,  
litteä taipuisa suojattu scart-  
kaapeli, 75 ohm videokaapelit

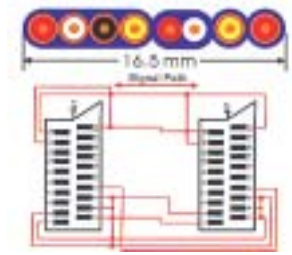

GT799S 1,5 m  
GT7993S 3 m

21-napainen, suojattu,  
litteä taipuisa suojattu scart-  
kaapeli, 75 ohm videokaapelit

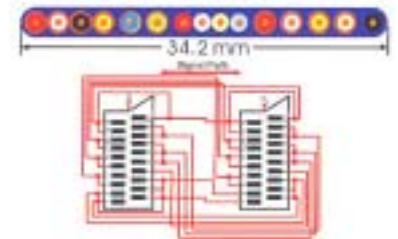

GT799 1,5 m  
GT7993 3 m

21-napainen, suojattu,  
litteä taipuisa suojattu scart-  
kaapeli, 75 ohm videokaapelit

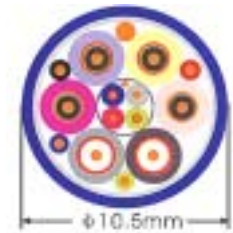

GT10 1,5 m  
GT105 5 m  
GT1010 10 m  
GT1015 15 m  
GT1020 20 m

DVI-kaapeli  
14 nap SCSI/14 nap SCSI



1:1 CONNECTED

GT11 1,5 m  
GT115 5 m  
GT1110 10 m  
GT1115 15 m  
GT1120 20 m

DVI-kaapeli  
14 nap SCSI/3 RCA pistoketta

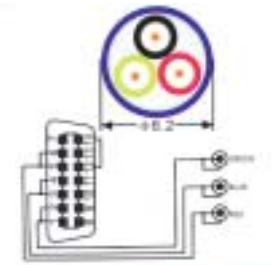

# VÄLIJOHDOT

## AV-JOHDOT

VR10 2 m

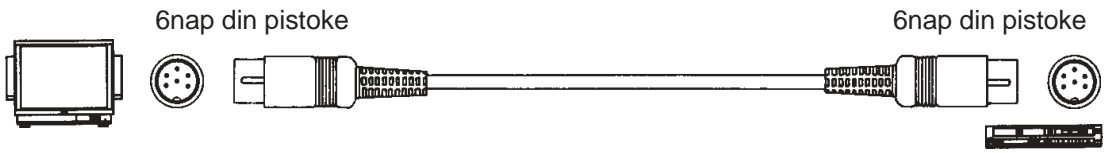

VR22 1,5 m

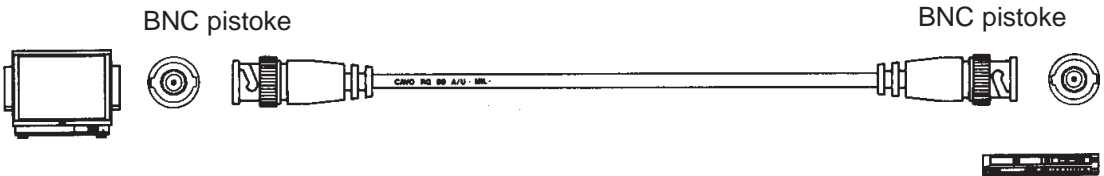

VR23 1,5 m

VR235 5 m

VR2310 10 m

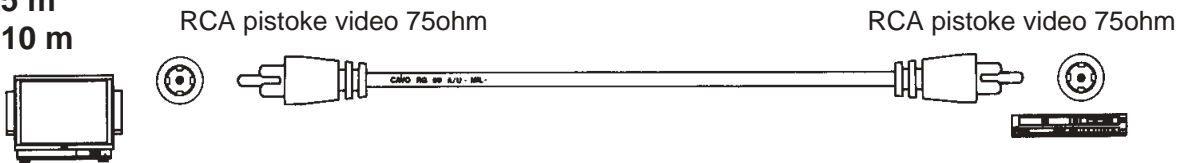

VR25 1,5m

VR254 4 m

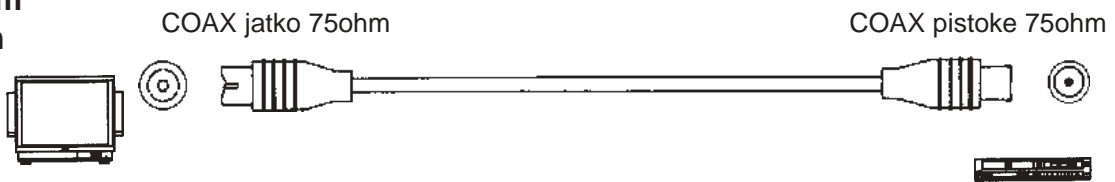

VR38 1,5 m

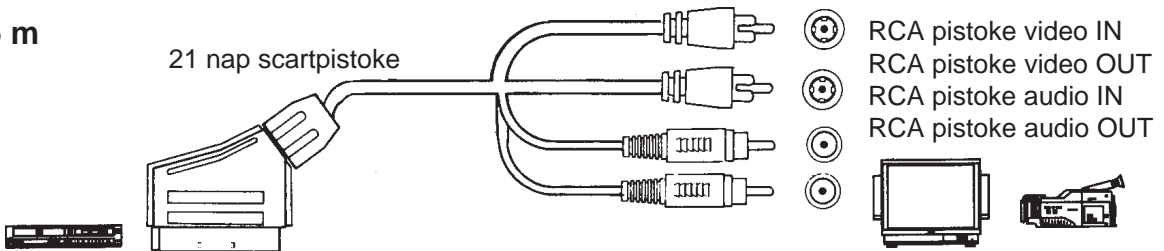

- RCA pistoke video IN
- RCA pistoke video OUT
- RCA pistoke audio IN
- RCA pistoke audio OUT

VR41 1,5 m

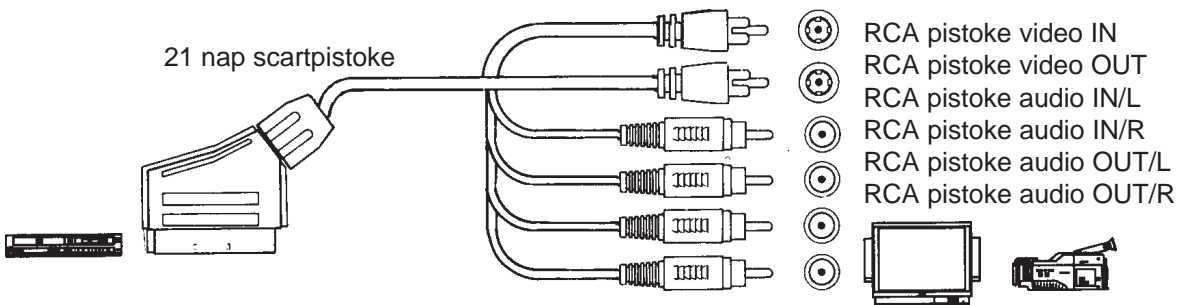

- RCA pistoke video IN
- RCA pistoke video OUT
- RCA pistoke audio IN/L
- RCA pistoke audio IN/R
- RCA pistoke audio OUT/L
- RCA pistoke audio OUT/R

### AGU-sarja

GR41 1,5 m

kullatut liittimet

# VÄLIJOHDOT

## AV-JOHDOT

VR45 1,5 m

21 nap scartpistoke

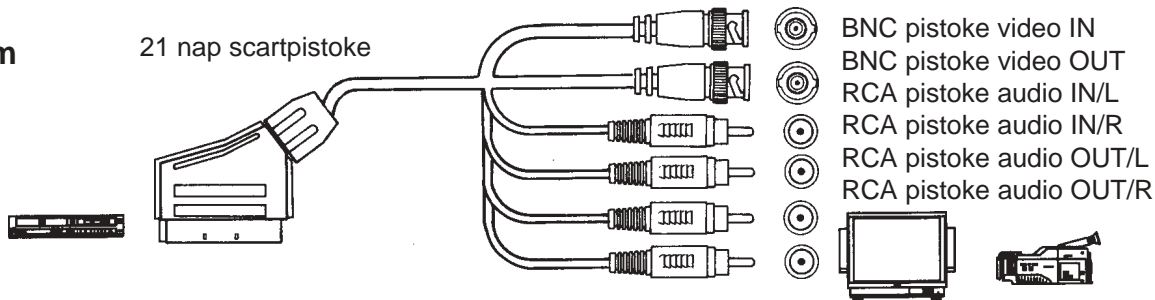

VR51 1,5 m

21 nap scartpistoke

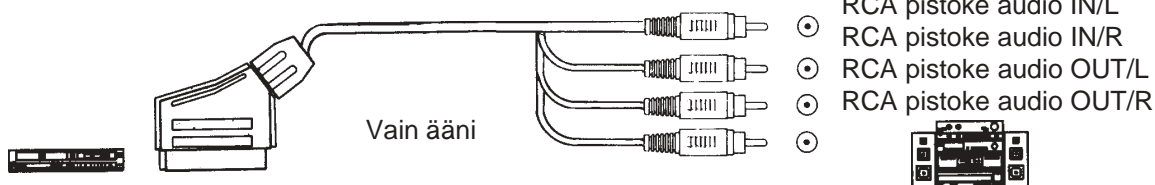

VR52 2 m

21 nap euroliitin

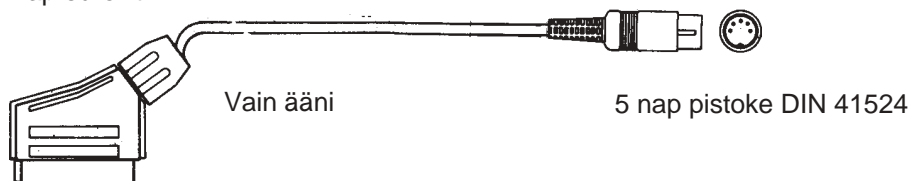

VR53 1,5 m

21 nap scartpistoke

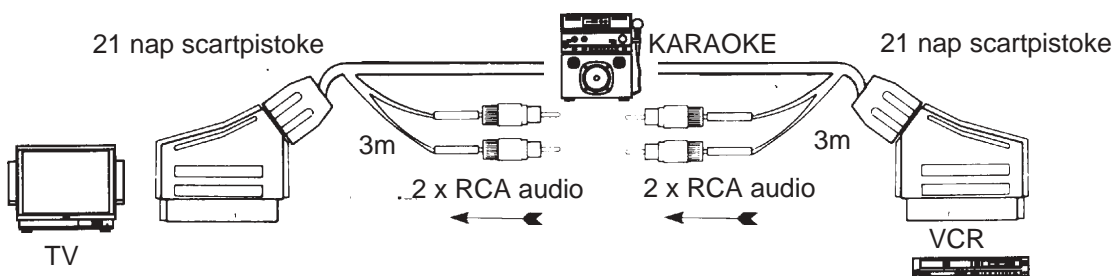

VR61 1,5 m

21 nap scartpistoke

8 nap din pistoke (DIN45326)

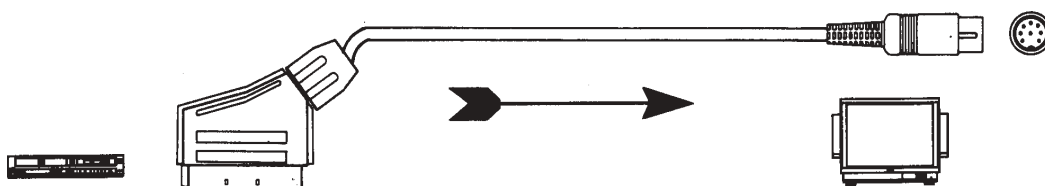

9972

kopiointisarja

- 1 6 nap din (välijohto)
- 2 6 nap din ty / 3 x RCA pistoke (välijohto)
- 1 5 nap din / 2 RCA jatko (välijohto)
- 2 BNC pistoke/RCA jatko adapteri
- 2 UHF pistoke/RCA jatko adapteri
- 2 3,5mm monoplugi/RCA jatko adapteri
- 1 SCART/6nap din jatko adapteri sisään
- 1 SCART/6nap din jatko adapteri ulos

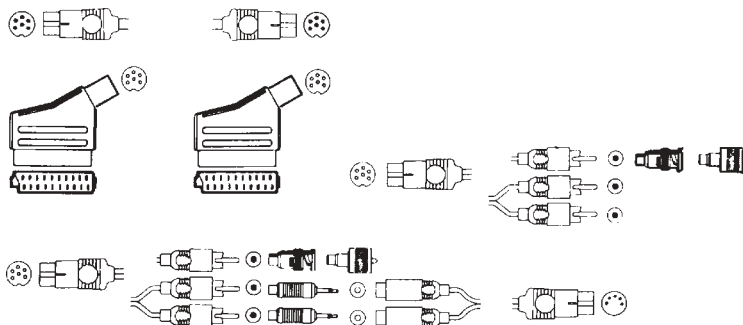



# VÄLIJOHDOT

## SuperVHS-JOHDOT

VR65 1,5 m  
VR653 3 m



SUPER VHS liitää SVHS+super

VR66 1,5 m  
VR663 3 m



SUPER VHS liitää SVHS+super

### AGU-sarja

GR65 1,5 m  
GR653 3 m



SUPER VHS liitää SVHS+super

### AGU-sarja

GR66 1,5 m  
GR663 3 m



SUPER VHS liitää SVHS+super

### HIGH END AGU-sarja

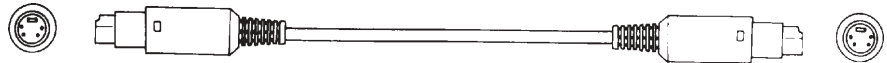

kullatut metallikuoriset liittimet

kaapelin ulkohalkaisija  $\varnothing$  6 mm

FE66 1,5 m  
FE6650 5 m  
FE66100 10 m

kaapelin ulkohalkaisija  $\varnothing$  8 mm

FE86 1,5 m  
FE8650 5 m  
FE86100 10 m  
FE86200 20 m



# VÄLIJOHDOT

## AV-JOHDOT

VR68 1,5 m

**S**VHS



21 nap scartpistoke

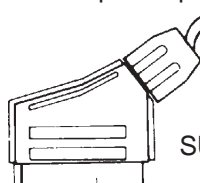

← SUPER VHS + audio →

4 nap minidin pistoke

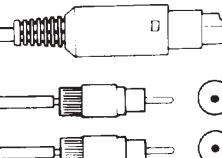

2 x RCA pistoke audio



VR69 1,5 m

**S**VHS



21 nap scartpistoke

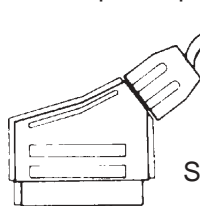

→ SUPER VHS + audio ←

4 nap minidin pistoke

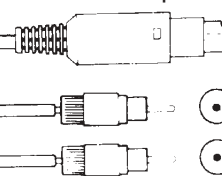

2 x RCA pistoke audio



VR70 5 m

21 nap scartpistoke

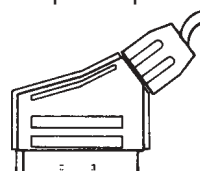

21 nap scartjatko

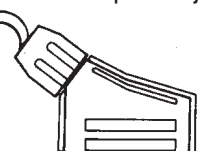

VR71 0,5 m



21 nap scartpistoke

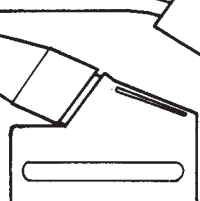
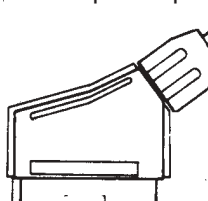

21 nap scartjatko



21 nap scartjatko

VR72 1,5 m



21 nap scartpistoke

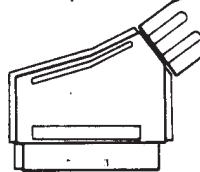

TV



VCR PLAY  
VCR REC

21 nap scartpistoke



21 nap scartpistoke

VR75 0,8 m

3,5 mm plugi, stereo

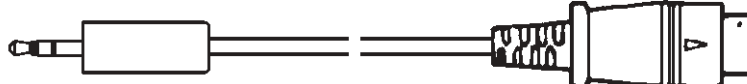

8 nap VIDEO/MOVIE audio/video



# VÄLIJOHDOT

## AV-JOHDOT

VR76 1,5 m



3,5mm plugi neljä kontaktia -

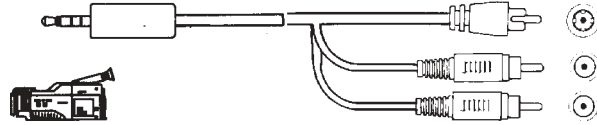

RCA pistoke video  
RCA pistoke audio  
RCA pistoke audio



VR77 1,5 m



RCA pistoke video  
RCA pistoke audio  
RCA pistoke audio

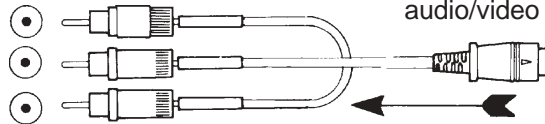

8 nap VIDEO MOVIE  
audio/video



VR78 1,5 m

21 nap scartpistoke

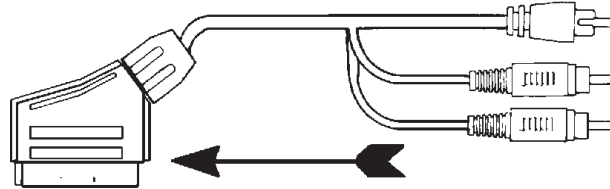
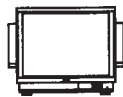

RCA pistoke video  
RCA pistoke audio L  
RCA pistoke audio R



GR78 1,5 m

21 nap scartpistoke

Kullatut liittimet

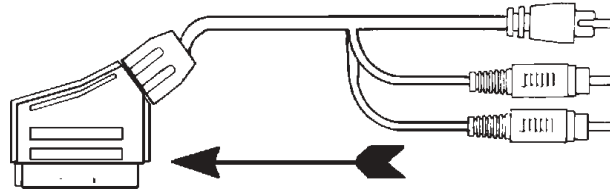
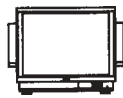

RCA pistoke video  
RCA pistoke audio L  
RCA pistoke audio R



**AGU-sarja**

VR78K 1,5 m

21 nap scartpistoke

Kytkimellä, IN/OUT

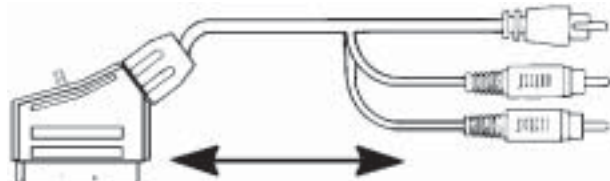

RCA pistoke video  
RCA pistoke audio L  
RCA pistoke audio R



VR82 1,5 m

RCA pistoke video  
2 x RCA pistoke audio stereo

RCA pistoke video  
2 x RCA pistoke audio stereo

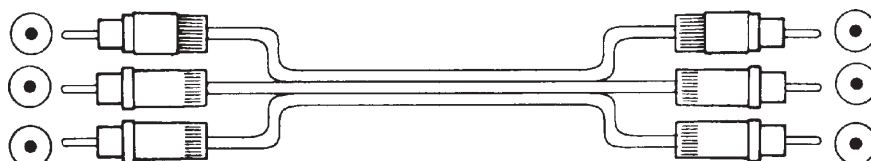

# VÄLIJOHDOT

## AV-JOHDOT

GR8205 0,5 m  
 GR8215 1,5 m  
 GR8230 3 m  
 GR8250 5 m

RCA pistoke video  
 2 x RCA pistoke audio stereo

RCA pistoke video  
 2 x RCA pistoke audio stereo



### AGU-sarja

Kullatut liittimet ja 75 ohm videokaapeli

VR84 1,5 m

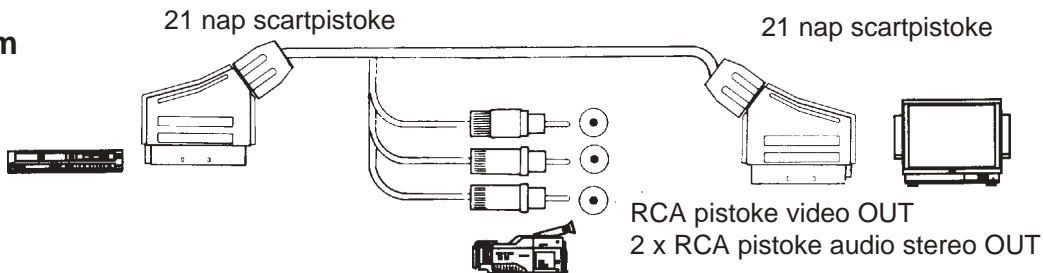

VR88 1,5 m

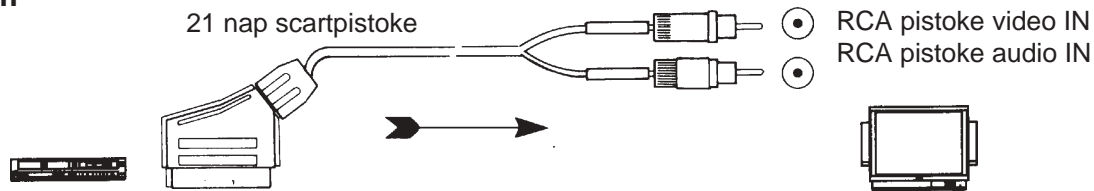

VR89 1,5 m

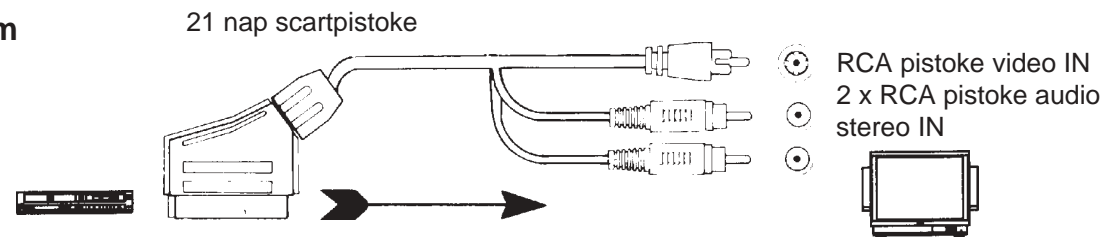

VR91 1,5 m

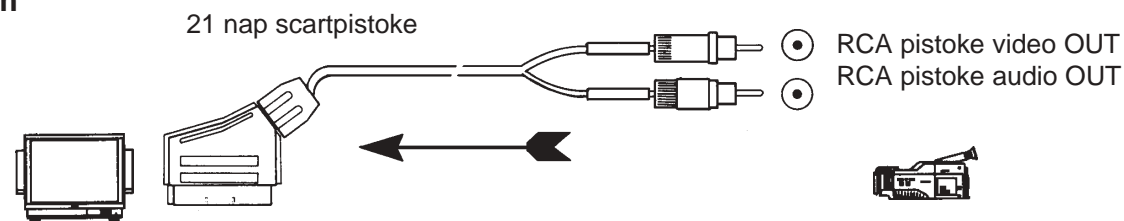

GR91 1,5 m

Kullatut liittimet

### AGU-sarja

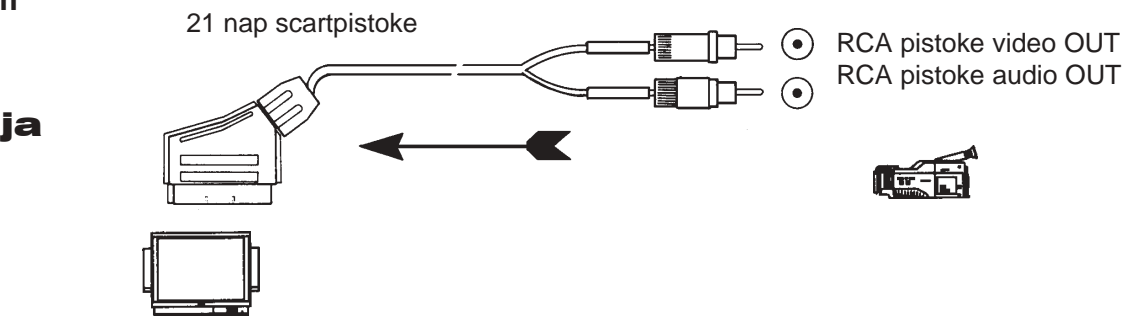

# VÄLIJOHDOT

## AV-JOHDOT

VR91A 1,5 m  
VR91A5 5 m

Ääni stereoilille

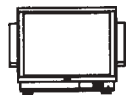

21 nap scartpistoke

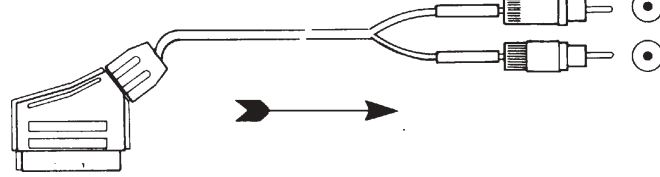

RCA pistoke audio IN  
RCA pistoke audio IN



GR91A 1,5 m  
GR91A3 3 m  
GR91A5 5 m

Ääni stereoilille  
kullatut liittimet

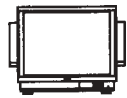

21 nap scartpistoke

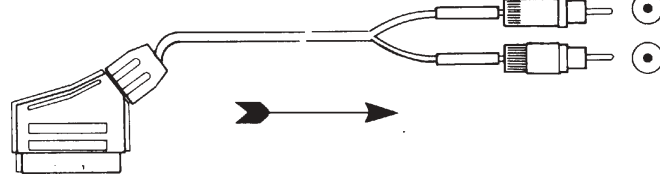

RCA pistoke audio IN  
RCA pistoke audio IN



### AGU-sarja

VR92 1,5 m



21 nap scartpistoke

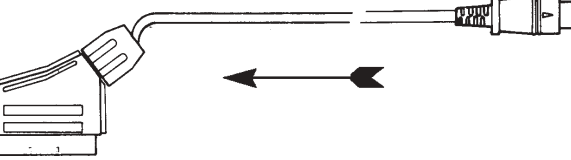

8 nap MOVIE pistoke audio,  
video ja heräte OUT



VR93 1,5 m



21 nap scartpistoke

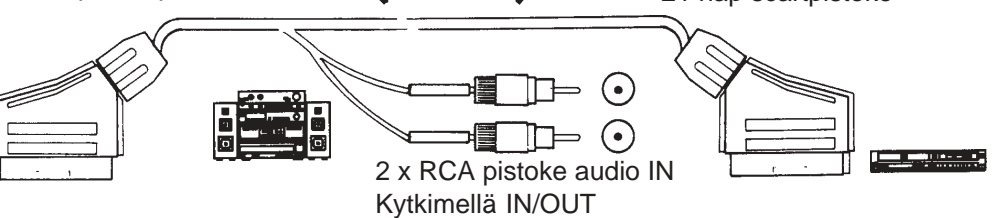

21 nap scartpistoke

2 x RCA pistoke audio IN  
Kytkimellä IN/OUT

GR93 1,5 m

Kullatut liittimet

### AGU-sarja



21 nap scartpistoke

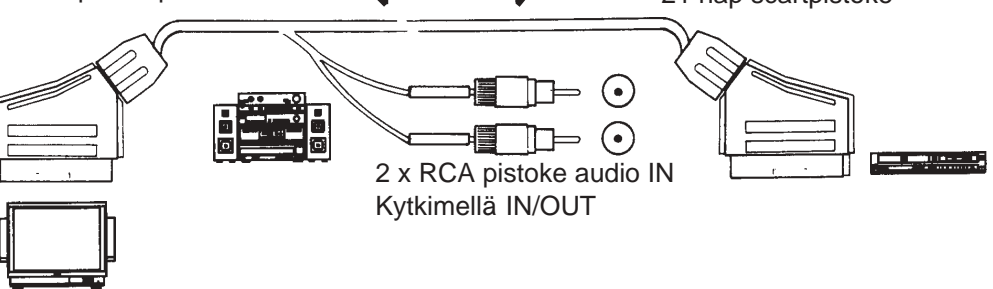

21 nap scartpistoke

2 x RCA pistoke audio IN  
Kytkimellä IN/OUT

VR99 1,5 m



21 nap scartpistoke

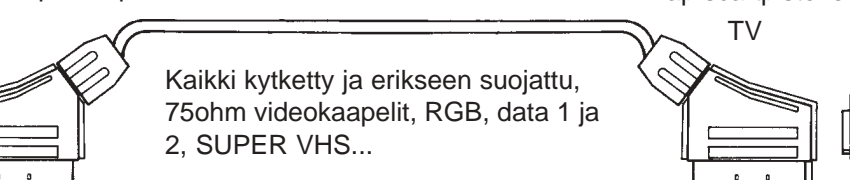

21 nap scartpistoke

TV

Kaikki kytketty ja erikseen suojattu,  
75ohm videokaapelit, RGB, data 1 ja  
2, SUPER VHS...



# VÄLIJOHDOT

## RCA-johdot

### EXPERT SERIES

<b>SXP1.5</b>	0,46 m
<b>SXP12</b>	3,7 m
<b>SXP17</b>	5,2 m
<b>SXP20</b>	6,1 m
<b>SXP3</b>	0,9 m
<b>SXP6</b>	1,8 m

#### SXPY2F

Y adapteri 2 RCA jatkoa/1 RCA pistoke

#### SXPY2M

Y adapteri 1 RCA jatko/2 RCA pistoketta



### DREAM SERIES

<b>SDS.5M</b>	0,5 m
<b>SDS1M</b>	1 m
<b>SDS2M</b>	2 m
<b>SDS4M</b>	4 m
<b>SDS5M</b>	5 m
<b>SDS6M</b>	6 m



### HYPER SERIES

<b>SHYP1.5</b>	0,46 m
<b>SHYP3</b>	0,9 m
<b>SHYP6</b>	1,8 m
<b>SHYP9</b>	2,7 m
<b>SHYP12</b>	3,7 m
<b>SHYP17</b>	5,2 m
<b>SHYP20</b>	6,1 m

#### SHYPY2F

Y adapteri 2 RCA jatkoa/1 RCA pistoke

#### SHYPY2M

Y adapteri 1 RCA jatko/2 RCA pistoketta

<b>SHYP417</b>	5,2 m
----------------	-------

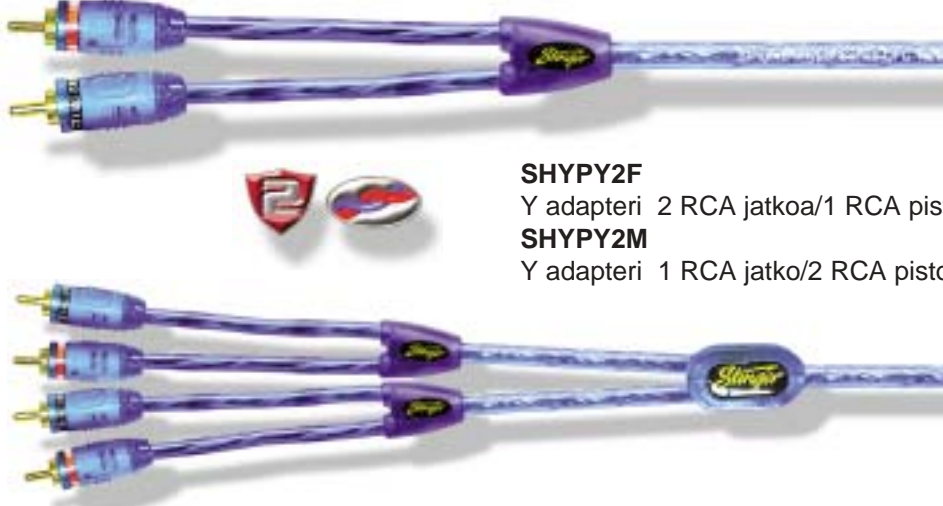

### NITRO SERIES

<b>SN1.5</b>	0,46 m
<b>SN3</b>	0,9 m
<b>SN6</b>	1,8 m
<b>SN9</b>	2,7 m
<b>SN12</b>	3,7 m
<b>SN17</b>	5,2 m
<b>SN20</b>	6,1 m

#### SNY2F

Y adapteri 2 RCA jatkoa/1 RCA pistoke

#### SNY2M

Y adapteri 1 RCA jatko/2 RCA pistoketta



### DRONE SERIES

<b>SD1.5</b>	0,46 m
<b>SD3</b>	0,9 m
<b>SD6</b>	1,8 m
<b>SD9</b>	2,7 m
<b>SD12</b>	3,7 m
<b>SD15</b>	4,6 m
<b>SD17</b>	5,2 m
<b>SD20</b>	6,1 m



**Stinger**

# VÄLIJOHDOT

## RCA-johdot

### AGU-sarja

TK1241G	1 m	RCA-kaapeli kullatuilla liittimillä, sininen kaapeli, ulkomitat $\varnothing$ 4 mm
TK1242G	2 m	
TK1245G	5 m	



TDB67161	1 m	RCA-kaapeli kullatuilla liittimillä, SININEN kaapeli, ulkomitat $\varnothing$ 6 mm
TDB67162	2 m	
TDB67165	5 m	



GK12305	0,5 m	RCA-kaapeli kullatuilla liittimillä, MUSTA kaapeli, ulkomitat $\varnothing$ 6 mm + HERÄTE
GK12315	1,5 m	
GK12330	3 m	
GK12350	5 m	



GR241	1 m	1 napainen RCA-kaapeli kullatuilla liittimillä, SININEN kaapeli, ulkohalkaisija $\varnothing$ 6 mm
GR242	3 m	
GR245	5 m	



GR2305	0,5 m
GR2315	1,5 m
GR2330	3 m
GR2350	5 m

1 napainen RCA-kaapeli kullatuilla  
pistokeilla, PUNAINEN kaapeli,  
ulkohalkaisija  $\varnothing$  8 mm  
(lukkiutuvat RCA liittimet)



# VÄLIJOHDOT AUDIOJOHDOT

TK102 1,5 m

3,5mm plugi mono

3,5mm plugi mono



TK107 1,5 m

5 nap din pistoke stereo

5 nap din pistoke stereo

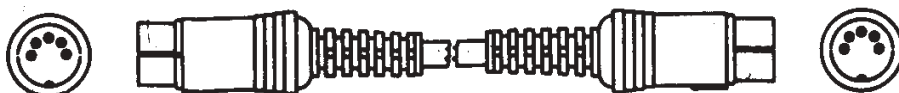

TK109 1,5 m  
TK1095 5 m  
TK10910 10 m

RCA pistoke

RCA pistoke



TK111 1,5 m  
TK11125 2,5 m  
TK11150 5 m

2 x RCA jatko

2 x RCA pistoke

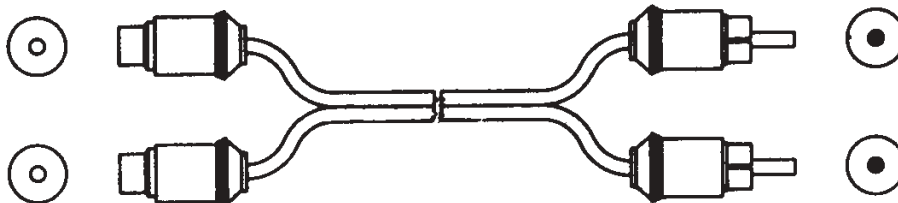

GK111 1,5 m  
GK11130 3 m  
GK11150 5 m

2 x RCA jatko

2 x RCA pistoke

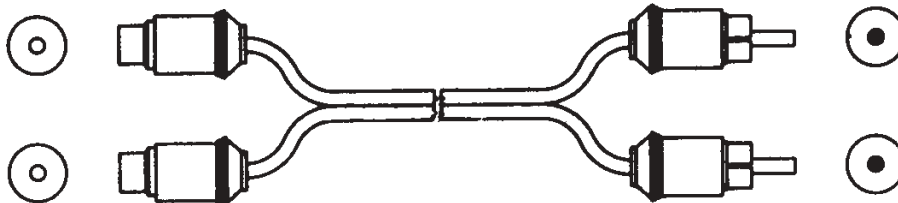

**AGU-sarja**

TK115 1,5 m

5 nap din pistoke stereo

5 nap din jatko stereo

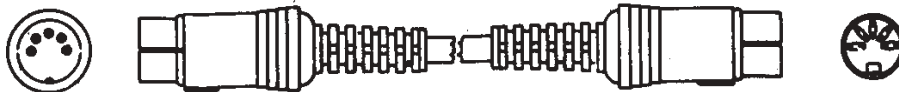

# VÄLIJOHDOT

## AUDIOJOHDOT

TK12405 0,5 m  
 TK124 1,5 m  
 TK1242 2 m  
 TK1243 3 m  
 TK1245 5 m  
 TK12410 10 m

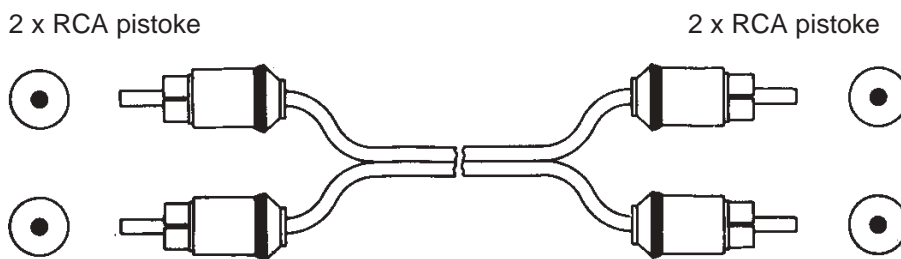

GK12405 0,5 m  
 GK124 1,5 m  
 GK1243 3 m  
 GK1245 5 m

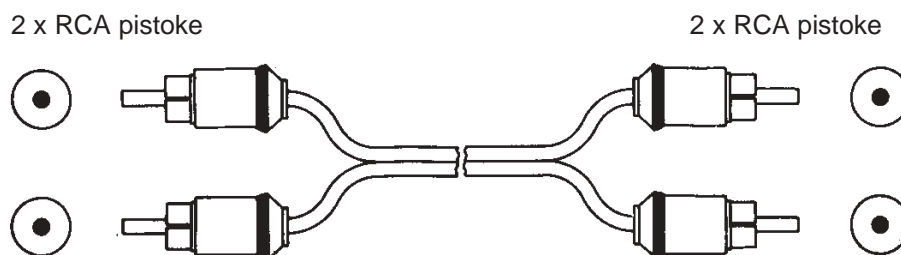

### AGU-sarja

TK127 1,5 m

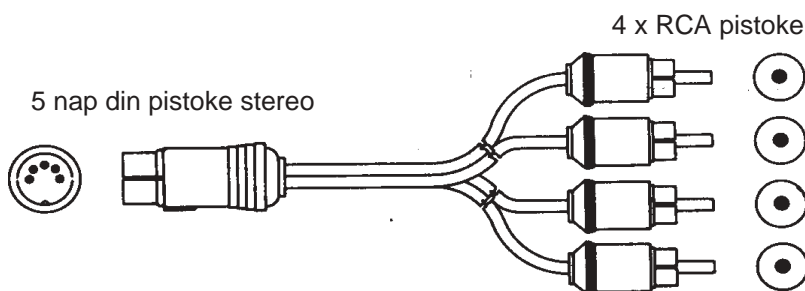

TK131 1,5 m

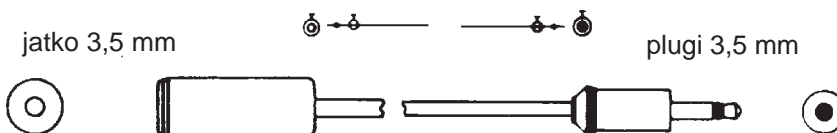

TK134 1,5 m

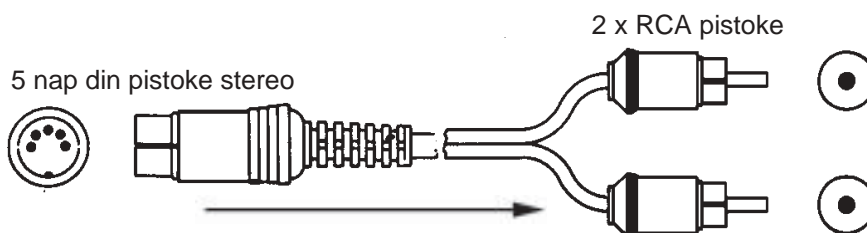

TK138C 0,2m

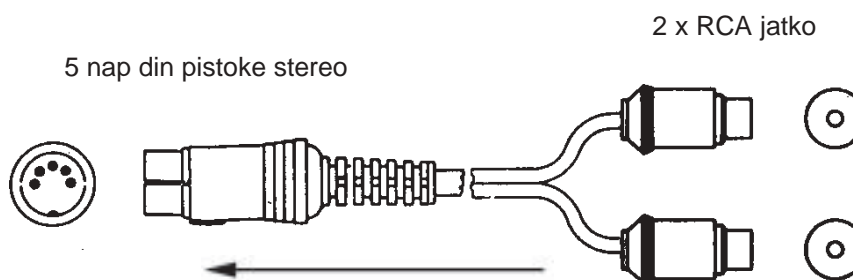

# VÄLIJOHDOT AUDIOJOHDOT

**TK147 0,2 m**

5 nap din jatko stereo

2 x RCA pistoke

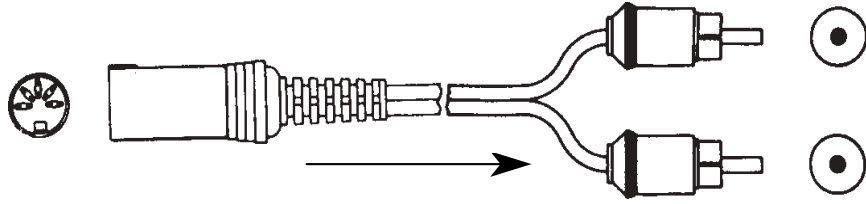

**TK149 0,2 m**

5 nap din jatko stereo

4 x RCA pistoke

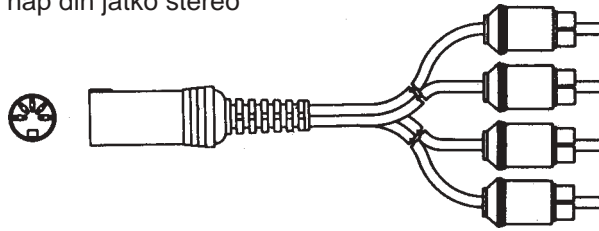

**TK150 1,5 m**

5 nap din pistoke stereo

5 nap din pistoke stereo

kopiointijohto (ristiinkytketty)

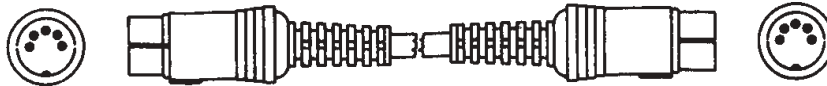

**TK156 1,5 m**  
**TK1562 2 m**

4 x RCA pistoke

4 x RCA pistoke

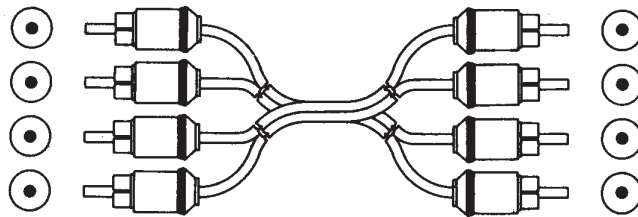

**TK168**

**0,2 m**

5 nap din pistoke stereo

4 X RCA jatko

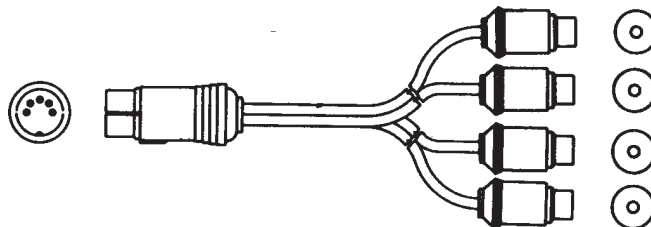

# VÄLIJOHDOT

## AUDIOJOHDOT

TK195 1,5 m 2,5mm stereo plugi 2,5mm stereo plugi  
TK1953 3 m



TK196 1,5 m 3,5mm stereo plugi 3,5mm stereo plugi  
TK1963 3 m



GK196 1,5 m 3,5mm stereo plugi 3,5mm stereo plugi

kullatut liittimet



### AGU-sarja

TK197 1,5 m 3,5 mm stereo plugi 3,5 mm stereo jatko  
TK1973 3 m



TK200 1,5 m 3,5mm plugi stereo 2 x RCA pistoke  
TK2003 3 m  
TK2005 5 m



GK200 1,5 m 3,5mm plugi stereo 2 x RCA pistoke  
GK2003 3 m  
GK2005 5 m  
kullatut liittimet



### AGU-sarja

TK214 1,5 m RCA pistoke 2 x RCA pistoke



# VÄLIJOHDOT AUDIOJOHDOT

TK215 0,2 m

RCA jatko

2 x RCA pistoke

**AGU-sarja**



TK2151 0,2 m

RCA pistoke

2 x RCA jatkoa

**AGU-sarja**



TK133 5 m

6,3mm stereo plugi

6,3mm stereo jatko



TK218 5 m

6,3mm plugi stereo

6,3mm jatko stereo

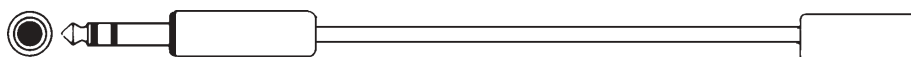

TK216 5 m

3,5mm plugi stereo

3,5mm jatko stereo



TK219 5 m

3,5mm plugi stereo

3,5mm jatko stereo



# VÄLIJOHDOT

## MIKROFONI JA INSTRUMENTTIIKAAPELIT

RF123 3 m  
RF126 6 m  
RF129 9 m  
RF1212 12 m



6,3 monopistoke/6,3 monopistoke  
C128, musta, Neutrik liittimet



RF223 3 m  
RF226 6 m  
RF229 9 m  
RF2212 12 m



6,3 monopistoke/XLR-jatko  
C128, musta, Neutrik liittimet



RF253 3 m  
RF256 6 m  
RF259 9 m  
RF2512 12 m



6,3 monopistoke/XLR-pistoke  
C265, musta, Neutrik liittimet



RF333 3 m  
RF336 6 m  
RF339 9 m  
RF3312 12 m



XLR-pistoke/XLR-jatko  
C128, musta, Neutrik liittimet



RF423 3 m  
RF426 6 m  
RF429 9 m  
RF4212 12 m



6,3 stereopistoke/6,3 stereopistoke  
C128, musta, Neutrik liittimet



seuraavat värit tehdastoimituksena:  
punainen, keltainen, vihreä, vaaleansininen  
sarja RF25\_ - vain mustana ja harmaana

välijohtoja saatavana myös seuraavilla Taskerin  
kaapeleilla: C208, C114, C260, C209, C300 ja C301

# VÄLIJOHDOT

## kaapelitesterit

258991



PC kaapelitesteri D, centr, vga, usbA-B...

PC-kaapelitesterillä voidaan testata yleisimpien datakaapeleiden - myös USB/1394-kaapeleiden - toimivuutta. Se paljastaa kaikki kaapeleissa ilmenevät poikkeavuudet. Hyvä työkalu kaapelimyyjille ja asentajille, jotka voivat nopeasti tarkistaa napajärjestyksen tai tehdä vikaselvityksen kaikissa työympäristöissä.

256551

Verkkotesteri RJ45 ja BNC (mast + rem)

LANtestillä voidaan helposti selvittää 10Base-T kaapeleiden (Cat 5), 10Base-2 kaapeleiden (coax) ja RJ45/RJ11 modularkaafeleiden oikea napajärjestys vertaamalla lähetyspäästä vastaavaan vastaanottopäähän. Kauko-ohjausyksiköllä voidaan testikaapelit asentaa etäälle seinälevystä tai väyläpaneelistä. Kaapelin jatkuvuus (avo-,oiko- tai ristikytkentä) voidaan helposti havaita.



256655

### LANID - LAN-testeri

LANID on helppokäyttöinen LAN-verkkojen vianetsintälaitte. Se on tarkoitettu verkkoasentajien työkaluksi, kun halutaan verkkojen asennusten tai korjauksien yhteydessä nopeasti selvittää mahdolliset ongelmat.

Yhden näppäimen painalluksella LANID näyttää verkossa sijaitsevien laitteiden tilan

sekä 10BASE-T- että 100BASE-T-verkoissa.

Lisäksi LANID:ssä on äänigeneraattori, joka jäljittää ne kaapelit, joilla on negatiivinen linkkistatus. Laite on pienikokoinen ja mukava käyttää myös kenttäolosuhteissa.



USB001

konverterri 25D / USB B pistoke  
1,8m kaapeli



USB002

konverterri USB A / 36 centronics  
1,8m kaapeli



USB003

USB kaapeli kahden koneen väliin  
1,8m kaapeli



# VÄLIJOHDOT

## USB johdot 2.0

TK10 1,8m  
TK1030 3 m  
TK1050 5 m

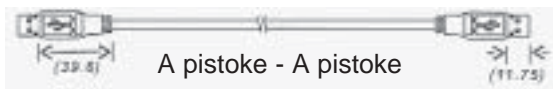

A pistoke - A pistoke



TK11 1,8 m



B pistoke - B pistoke

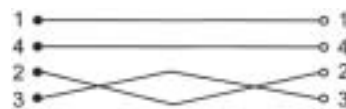

TK12 1,8 m  
TK1230 3 m  
TK1250 5 m



A pistoke - B pistoke



TK13 1,8 m  
TK1330 3 m  
TK1350 5 m

### USB jatko kaapelit

A pistoke - A jatkopistoke



TK18 1,8m  
TK1830 3 m  
TK1850 5 m

### MINIUSB kaapeli

A pistoke - Mini A pistoke



# VÄLIJOHDOT

## FIREWIRE IEEE1394 johdot

**TK17 1,8 m**  
**TK1730 3 m**

6 nap pistoke/  
4 nap pistoke

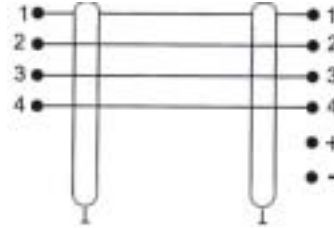

**TK16 1,8 m**  
**TK1630 3 m**

6 nap pistoke/  
6 nap pistoke

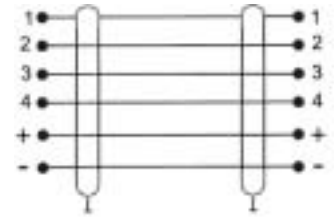

**TK14 1,8 m**  
**TK1430 3 m**

4 nap pistoke/  
4 nap pistoke

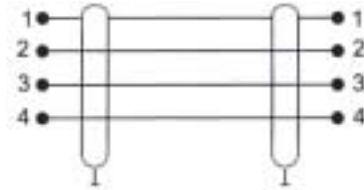

**DV2000V4**

IEEE1394 sovitinkortti  
PCI-väylään  
kolme FIREWIRE väylää



# VÄLIJOHDOT TIETOKONEJOHDOT

**TK43K 1,8 m**  
kaikki navat kytketty

25 nap D-pistoke

25 nap D-pistoke

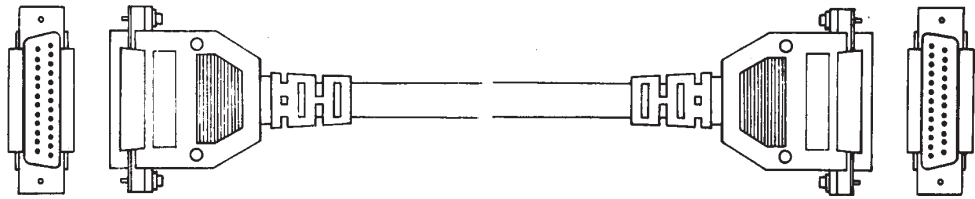

**TK43 1,8 m**  
**TK433 3 m**

kaikki navat kytketty  
hyvä suojaus,  
parikierretty kaapeli

25 nap D-pistoke

25 nap D-pistoke

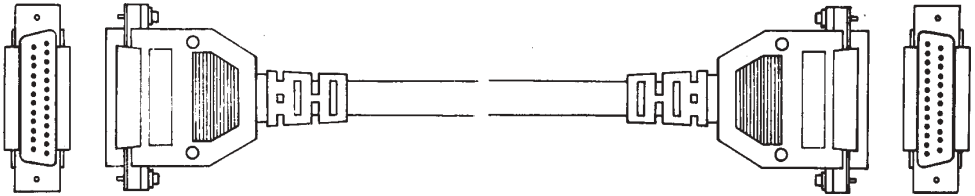

**TK46K 1,8 m**

kaikki navat kytketty



25 nap D-pistoke

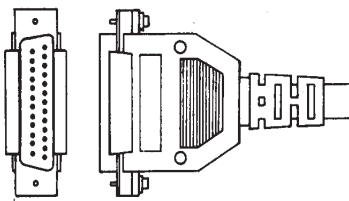

36 nap Centronics pistoke

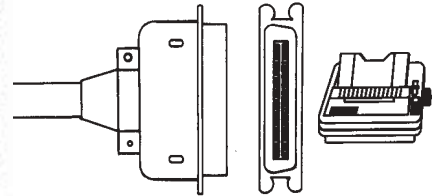

**TK46 1,8 m**  
**TK463 3 m**

kaikki navat kytketty  
IEE 1284



25 nap D-pistoke

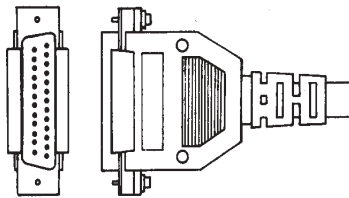

36 nap Centronics pistoke

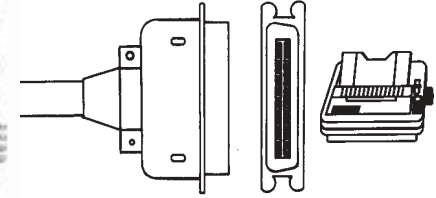

**TK47 1,8m**

15 nap 3rivinen D-pistoke

15 nap 3rivinen D-pistoke

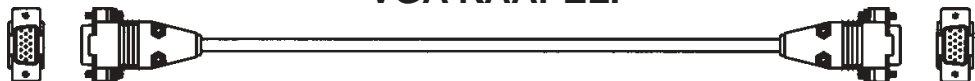

**VGA KAAPELI**

**TK48 1,8m**

15 nap 3rivinen D-pistoke

15 nap 3rivinen D-jatko



**VGA KAAPELI**



# VÄLIJOHDOT TIETOKONEJOHDOT

**TK52** 1,8 m  
**TK5230** 3 m  
**TK5250** 5 m

hyvälaatuinen SVGA kaapeli  
15 D pistoke 3-rivi/15 D jatko 3-rivi  
75 ohm coaxial-kaapelit



**TK53** 1,8 m  
**TK5330** 3 m  
**TK5350** 5 m

hyvälaatuinen SVGA kaapeli  
15 D pistoke 3-rivi/15 D pistoke 3-rivi  
75 ohm coaxial-kaapelit



**TK5430** 3 m

nollamodeemikaapeli  
9 D jatko/9 D jatko  
25 D jatko/25 D jatko  
8 napaa kytketty



**TK5530** 3 m

nollamodeemikaapeli  
9 D jatko/9 D jatko  
8 napaa kytketty



**TK5630** 3 m

nollamodeemikaapeli  
25 D jatko/25 D jatko  
8 napaa kytketty

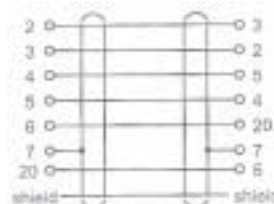

**TK57** 1,8 m  
**TK5730** 3 m  
**TK5750** 5 m

PS/2 kaapeli  
Mini DIN 6 pistoke/  
Mini DIN 6 jatko



# VÄLIJOHDOT

## TIETOKONEJOHDOT

**TK60** 1,8 m

hyvälaatuinen SVGA kaapeli  
15 D pistoke 3-rivi/5 BNC pistoketta  
75 ohm coaxial-kaapelit

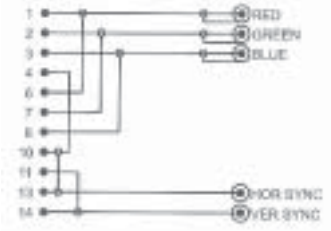

**TK59** 1,8 m

MIDI KAAPELI  
15 D pistoke/15 D jatko adapteri  
+ kaksi 5 nap DIN pistoketta



**TK19** 0,2 m

Peliportinjakaja



**8641** 3m

super Nintendon AV-johto  
audio stereo/video, 3m

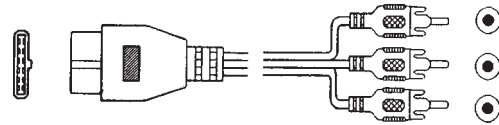

**TK67**

14 nap tiheä centronics pistoke

15 nap D-pistoke

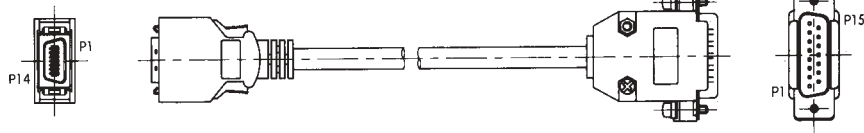

**TK68**

14 nap tiheä centronics pistoke

9 nap D-pistoke

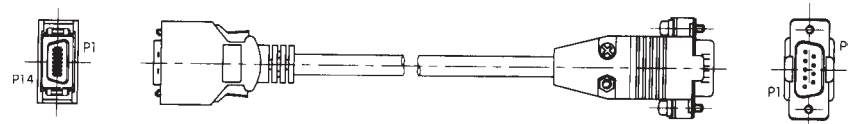

**TK69**

68 nap tiheä D-pistoke

68 nap tiheä D-pistoke

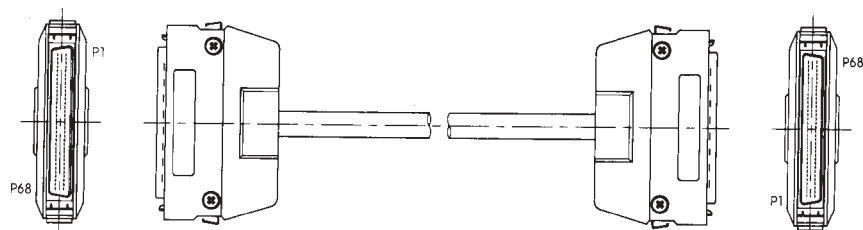

# VÄLIJOHDOT TIETOKONEJOHDOT

**TK58** 1,8 m

50 centronics pistoke

25 D pistoke

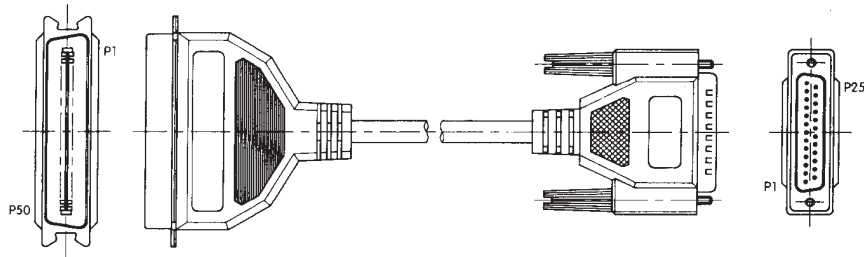

**TK62**

50 nap tiheä centronics pistoke

50 nap tiheä centronics pistoke

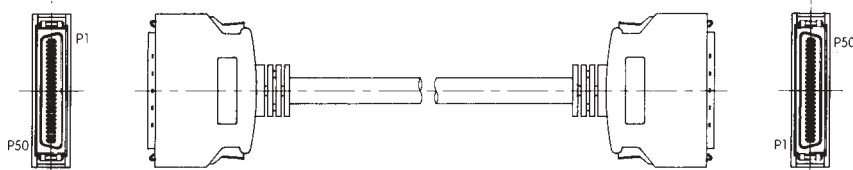

**TK63**

26 nap tiheä centronics pistoke

25 nap D-pistoke

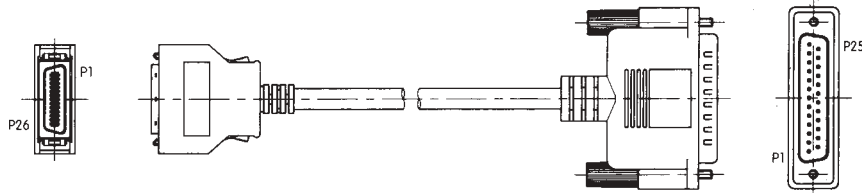

**TK64**

50 nap tiheä D-pistoke

50 nap tiheä D-pistoke

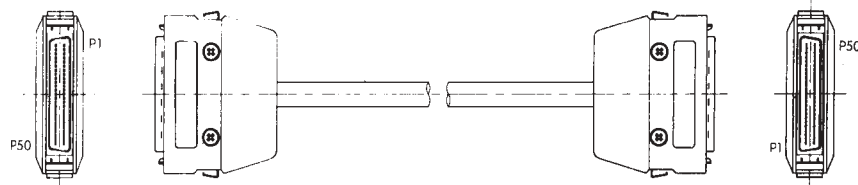

**TK65**

20 nap tiheä centronics pistoke

25 nap D-pistoke

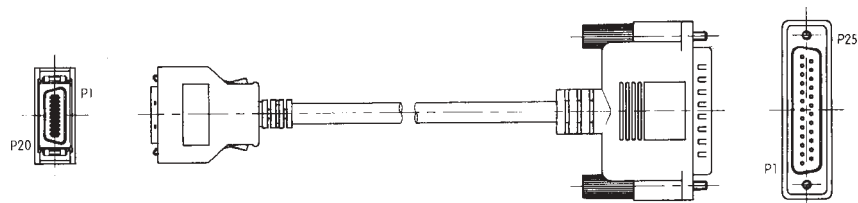

**TK66**

14 nap tiheä centronics pistoke

25 nap D-pistoke

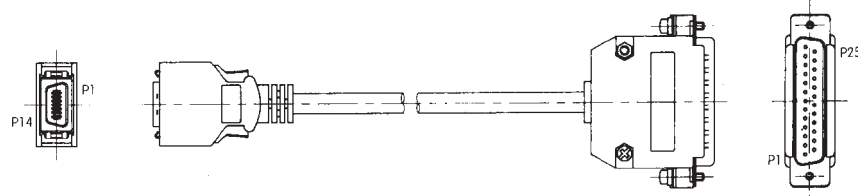

# VÄLIJOHDOT

## VERKKOKAAPELIT

### CAT 5e

#### CAT5e väyläkaapelit UTP harmaa

UR4506	0,6 m
UR4510	1 m
UR4520	2 m
UR4530	3 m
UR4550	5 m
UR45100	10 m
UR45125	12,5 m
UR45150	15 m
UR45175	17,5 m
UR45200	20 m

Kategoria -5e kaapelit ovat UL-, CSA- ja ETL hyväksytyjä.

- 100 ohm
- CAT5e 350 MHz
- EIA/TIA T568B/T568B

Ristiinkytketty väyläkaapeli kahden koneen väliin ilman keskitintä, tunnistus: punaiset liittinsuojat

#### CAT5e väyläkaapelit FTPsuojatut harmaa

SR4506	0,6 m	
SR4510	1 m	
SR4510RD	1 m	punainen
SR4520	2 m	
SR4520BL	2 m	sininen
SR4520RD	2 m	punainen
SR4530	3 m	
SR4540	4 m	
SR4550	5 m	
SR4570	7 m	
SR45100	10 m	
SR45150	15 m	
SR45300	30 m	



#### CAT5e väyläkaapelit FTP ristiinkytketty harmaa, punaiset liittimet

SRX4510	1 m
SRX4530	3 m
SRX4550	5 m
SRX45100	10 m
SRX45150	15 m

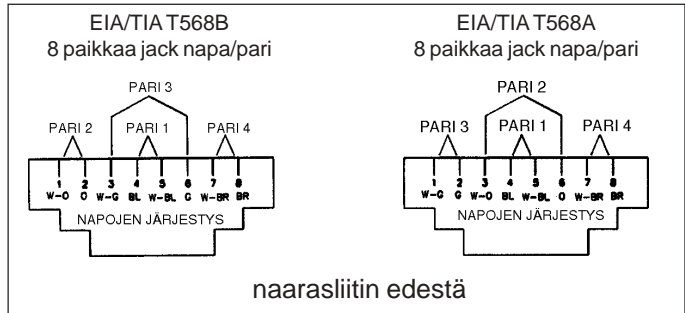

#### CAT5e väyläkaapelit T568B



pari	napa	tunnus	tehtävä	värit
2	1	TX-D1 +	Transmit data +	oranssi/valkoinen
2	2	TX-D1 -	Transmit data -	oranssi
3	3	RX-D2 +	Receive data +	vihreä/valkoinen
1	4	BI-D3 +	Bi-directional data +	sininen
1	5	BI-D3 -	Bi-directional data -	sininen/valkoinen
3	6	RX-D2 -	Receive data -	vihreä
4	7	BI-D4 +	Bi-directional data +	ruskea/valkoinen
4	8	BI-D4 -	Bi-directional data -	ruskea



#### CAT5e väyläkaapelit ristiinkytketty



ristiinkytketyssä kaapelissa seuraava kytkentä

TX-D1 +	1-----3	RX-D2 +
TX-D1 -	2-----6	RX-D2 -
RX-D2 +	3-----1	TX-D1 +
RX-D2 -	6-----2	TX-D1 -

muut liittimet kytketty suoraan



# VÄLIJOHDOT

## MODULAR-LIITÄNTÄJOHDOT

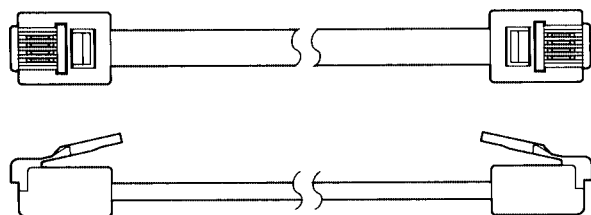

tilausnumeron valinta





**TT**      **6**    **4**    **2**  
 ①            ②      ③      ④

Modularkaapelliitöntäjohto, säikeinen kuparikaapeli PVC suojuksella. Johdon molemmissa päissä on liitin. Pituudet: 2 m, 4 m, 7 m ja 10 m

### ① sarja

TT puhelinkäyttö  
 TA atk-käyttö  
 (ristiinkytketty)

### ③ kontaktien määrä

8 8 kontaktia   
 6 6 kontaktia   
 4 4 kontaktia   
 2 2 kontaktia 

### ② liitin

8 8 napainen  
 6 6 napainen  
 4 4 napainen

### ④ kaapelin pituus m

2 2 m  
 4 4 m  
 7 7 m  
 10 10 m

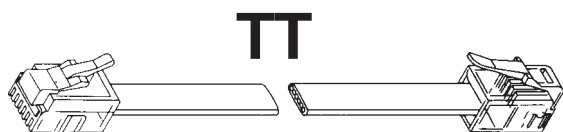

**TT**

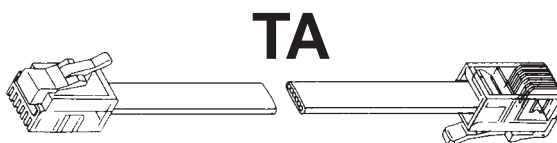

**TA**

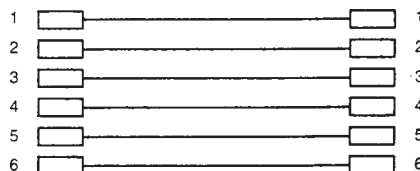
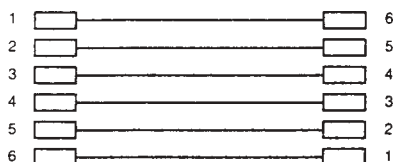

**TT44SP 1,5 m**  
**TT44SP5 5 m**  
 Puhelinmodularjohto 4nap kierre

**TT66SP**  
 Puhelinmodularjohto 6nap kierre

**TT88SP**  
 Puhelinmodularjohto 6nap kierre



pituus 1,5m suorana

# VÄLIJOHDOT

## PUHELINJOHDOT ja ADAPTERIT

**P001**

Puhelinpistoke 3 nap



**P002**

Puhelinpistoke 3 nap/modular  
6/3 kont.



**P008**

Puhelinpistoke 5 nap/modular  
6/3 kont.



**P003**

Puhelinvälkosketin 3 nap/modular  
6/3 kont.



**P004**

Puhelinvälkosketin 5 nap/modular  
6/5 kont.



**P007**

puhelinjatkopistoke 3 nap/  
modular  
6/3 kont.



**TT353**

3m

**TT356**

6m

**TT3510**

10m

puhelinjatkajohto 5 nap liittimet



**P009**

puhelinjatkopistoke 5 nap/  
modular  
6/3 kont.



**P43**

puhelinjohdon nivel 4 nap  
modularliittimellä



**TT343**

3m

**TT346**

6m

**TT3410**

10m

puhelinjohto 6 nap modular/3 nap  
puhelinpistoke



**TT313**

3m

**TT316**

6m

**TT3110**

10m

puhelinjatkajohto 3 nap liittimet



**TT323**

3m

**TT326**

6m

**TT3210**

10m

puhelinjatkajohto välkoskettimella  
3 nap liittimet



**TT1447**

puhelinjatkajohto 6 nap mod/6  
nap mod jatko  
7 m



**TT2447**

puhelinjatkajohto 6 nap mod/2 x  
6 nap mod jatko  
7 m



**TT3305**

puhelinhaaroitusjohto 3 nap 0,5 m



# VÄLIJOHDOT

## PUHELINADAPTERIT JA KYTKENTÄRSIAT

### TFPR661FM

Modularadapteri 6 nap pistoke/  
2 x 6 nap jatko



### TFPR881FM

Modularadapteri 8 nap pistoke/  
2 x 8 nap jatko



### TFPR661FF

Modularadapteri 6 nap jatko/  
2 x 6 nap jatko



### TFPR663FM

Modularadapteri 6 nap pistoke/  
3 x 6 nap jatko



### TFPR665FM

Modularadapteri 6 nap pistoke/  
5 x 6 nap jatko



### Modular/puhelinliittimet liittinosassa



### TFPR44FF

Modularjatkoadapteri 4 nap

### TFPR44FFR

Modular jatkoadapteri 4 nap  
ristiinkytketty



### TFPR66FF

Modularjatkoadapteri 6 nap

### TFPR66FFR

Modularjatkoadapteri 6 nap  
ristiinkytketty



### TFPR88FF

Modularjatkoadapteri 8 nap

### TFPR88FFR

Modularjatkoadapteri 8 nap  
ristiinkytketty



### TFPR884MF

8n pistoke/4 jatkoa



### TFPR885MF

8n /5 jatkoa terminoitu 100 ohm



### TFPR888MF

8n pistoke/8 jatkoa,  
terminointi valittavissa kytkimellä



### TFPRM44

Modular kytkentärasia 4 nap

### TFPRM64

Modular kytkentärasia 6 nap, neljä kytketty

### TFPRM66

Modular kytkentärasia 6 nap, kuusi kytketty

### TFPRM88

Modular kytkentärasia 8 nap

