

LIITTIMET

SMA/SMB

Amphenol-Kai Jack SMA liittimet ovat pienikokoisia liittimiä, jotka toimivat luotettavasti suurilla taajuuksilla (0 - 18 GHz asti) pienellä heijastushäviöllä, 50 ohmin impedansilla.

Tarkemmat ominaisuudet ovat hyvä mekaaninen lujuus, kestävyys ja pieni jännitteen seisovanaallonsuhde (VSWR).

0880030G
puristettava pistoke, taipuisa kaapeli, kullattu



207405 RG58
jatkoadapteri

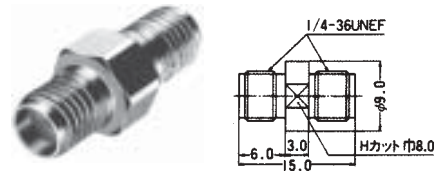

7013174
pistoke puristettava 174 suora kullattu SMA1111A2-3GT50G-316

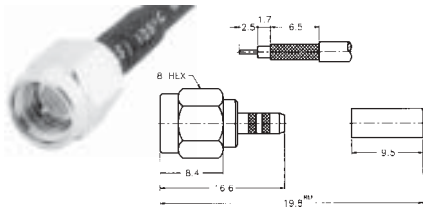

7023174
jatko puristettava RG174 SMA6111AU-3GT50G-316

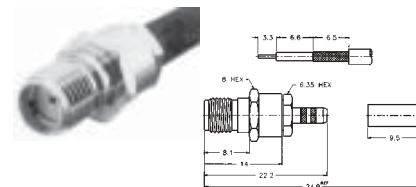

7023058
jatko puristettava RG58

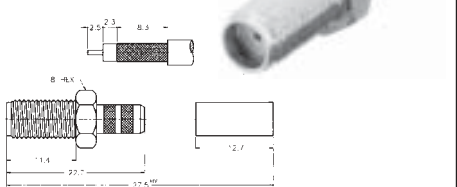

7014174
pistoke puristettava kulma RG174 SMA1112A5-NT50G-174U

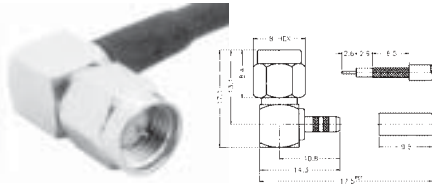

7014058
pistoke puristettava kulma RG58 SMA1112A6-NT50G 58U-

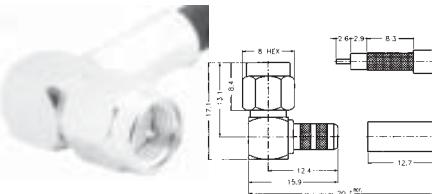

7046050
runko kulma pp

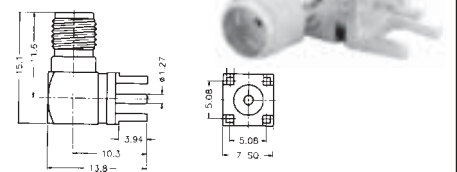

0882064P
kulma runko

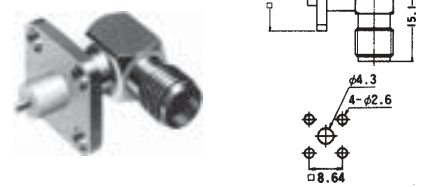

0885021G
runko RG188, 318 kullattu

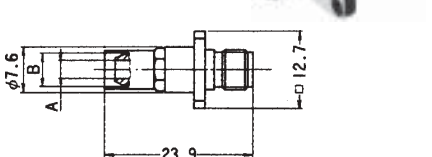

Amphenol-Kai Jack SMB ja SMC ovat pienikokoisia coaxiaaliliittimiä 50 ohmin impedansilla, taajuuksille 4 GHz (SMB) tai 10 GHz asti (SMC).

SMB liittimen liitöntä tapa on nopea snap-on liitanta. SMC liittimissä on kierrelitanta.

SMB ja SMC liittimet ovat yleensä edullisempia kuin SMA liittimet. Niiden tyypillisä käyttökohteita ovat lyhytaaltopuhelimet (microwave)

7113174
SMB pistoke puristettava suora RG174/316 SMB6121A1-NT30G-316U

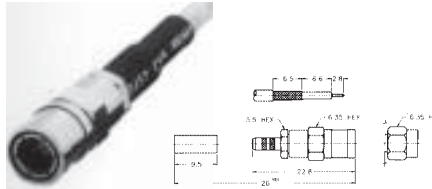

7114174
SMB jatko puristettava kulma RG174/316 SMB6112A1-NT3G-174U



7124174
SMB jatko puristettava kulma RG174 SMB1112A1-NT3G-174U

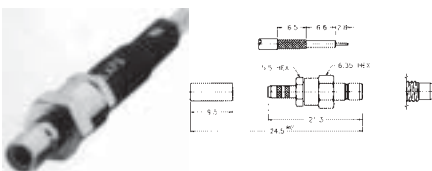

0800028
SMB pistoke kulma RG178,196



7146050
SMB runko kulma pp

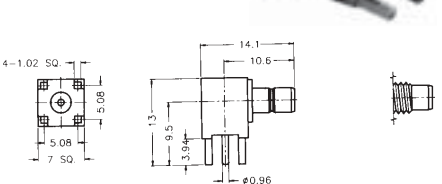

LIITTIMET

BNC pistokkeet

Amphenol-Kai Jack BNC liittimet ovat korkealaatuisia coaxiaali liittimiä 50 ohm impedansilla 4 GHz asti ja 75 ohm impedansilla 1 GHz asti.

BNC liittimet kiinnittyvät bajonettilukituksella. Kaapelin liitääntä tapahtuu joko täysin puristamalla tai kierrelitoksella, jolloin keskijohdin juotetaan.

Seisovanaallonsuhde (SWR) 1000 MHz:llä 1.15:1

Impedanssi	50 ohm	75 ohm
Taajuusalue	0-4 GHz	0-1 GHz
Käyttöjännite	500 V rms	500 V rms
Dielektrinen kestävyys, jännite	1500 V rms	1500 V rms
VSWR	1.3 max. 0 - 4 GHz	1.05 + 0.1f (GHz) 0-1 GHz
Kontaktivastus	Keskikontakti 1.5 mohm Ulkokontakti 1.0 mohm	Keskikontakti 1.5 mohm Ulkokontakti 1.0 mohm
Eristysvastus	5000 Mohm (min)	5000 Mohm (min)

0501396K

pistoke kulma mutteri RG58

0501398

pistoke kulma mutteri RG59

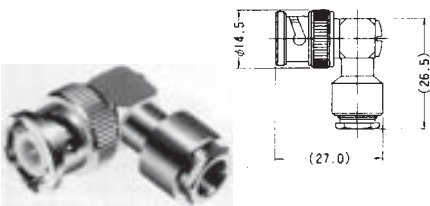

20301

pistoke mutteri RG58

203019

pistoke mutteri RG59

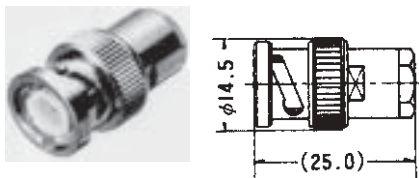

20305 RG58

20305174 RG174

20305213 RG213

pistoke puristettava



5013006 RG6,MK95, TELLU 13

5013058 RG58 B1121A1

5013059 RG59 B1121A1

5013174 RG174 B1121E1

5013179 RG179 B1121E1 75 ohm

5013213 RG213 B1121A1

pistoke puristettava

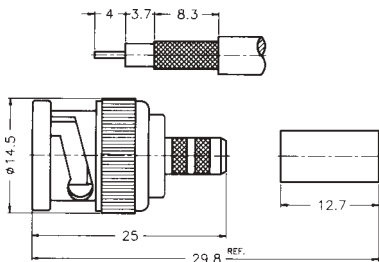

0501490

jatko ruuvikiinnitys RG58

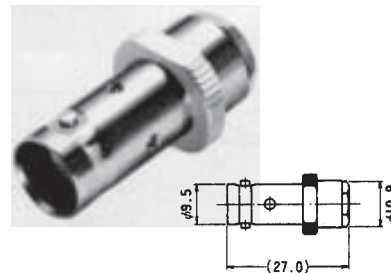

5014058

pistoke kulma puristettava RG58,
juotettava keskijohdin
B1112B1-ND3G-58C/U-5

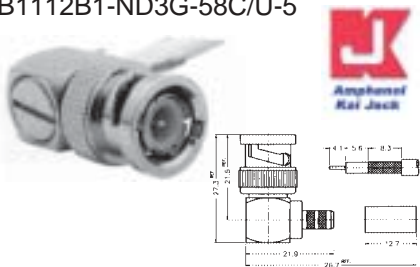

5014174

pistoke kulma puristettava RG174,
juotettava keskijohdin
B1112F1-ND3G-174U-50



20350

pistoke kulma puristettava RG58



0900110 10dB 0-500MHz

0900103 3dB 0-500 MHz

0900106 6dB 0-500MHz

vaimennin



50910501

pääte 0-500MHz 50ohm

0900520

pääte 0-500 MHz 75ohm



5081005

suojahattu

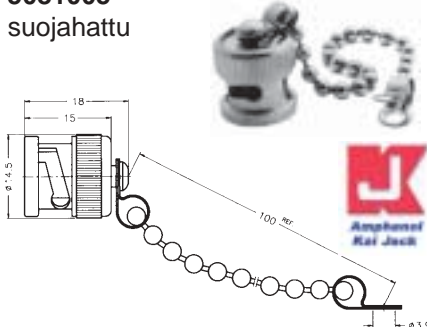

LIITTIMET

BNC adapterit

2051103
jatko pistoke-pistoke



2052201 sileä pinta*
B7071A2-ND3G-50
2052203 karhea pinta*
B7071A1
jatko jatko-jatko

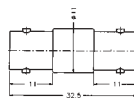

2051210
kulma adapteri

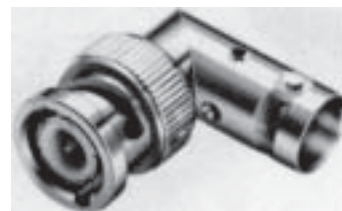

20512283
T-liitin pistoke-2xjatko Y-malli

2052241
läpivienti mutterilla B7471B1

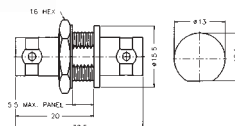

2052243
läpivienti mutterilla



20522271
T-liitin 3xjatko vahvistettu B8073A1

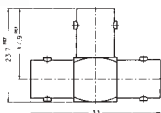

20522263
T-liitin 3xjatko



20522271
T-liitin 3xjatko vahvistettu



20512273
T-liitin pistoke-2xjatko vahvistettu



20512261
T-liitin pistoke-2xjatko



LIITTIMET

TNC pistokkeet ja jatkot

0502100K
pistoke RG58 mutteri

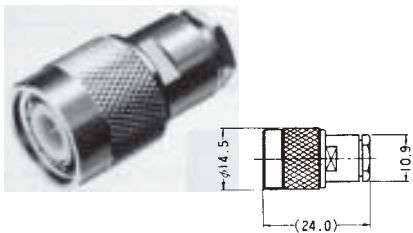

0502110
pistoke kulma puris RG 58

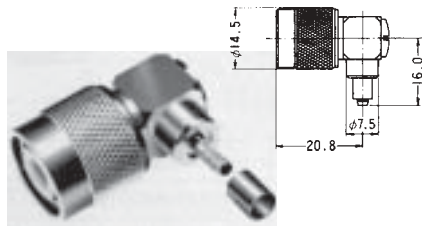

0502114
pistoke kulma mutteri RG58

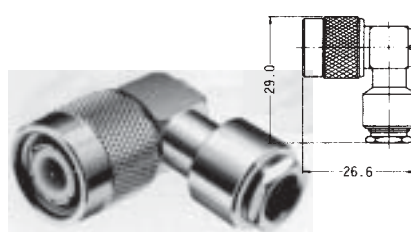

6013058
pistoke puristettava RG58
T1121A1-ND3G-58 C/U

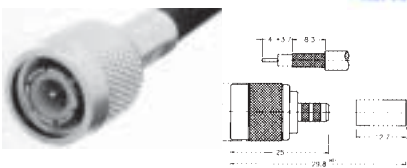

20402174 RG174
204026 RG6
204029 RG59
20432 RG 58
pistoke puristettava



6023058
jatko puristettava RG58
T6121B1

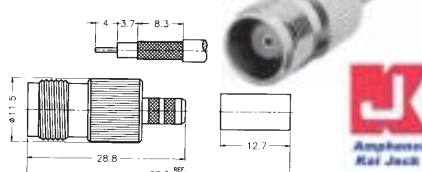

20417
jatko ruuvattava RG58



2062241
läpivienti jatko/jatko
T7471A1



2061213
kulma-adapteri



2061103
jatko pistoke/pistoke



2062201
jatko jatko/jatko
T7071A2ND3G

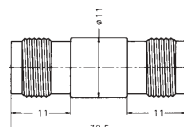

6043058
6043058E eristetty
runko jatko eristetty
puristettava RG58
T6721B1

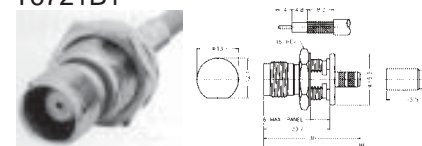

6043174
runko jatko puristettava 174 KJ
T6721E1

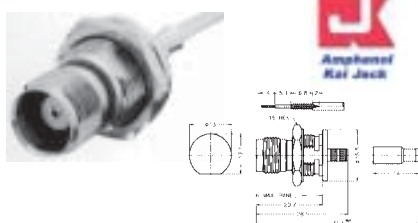

20622263
t-liitin 3xjatko

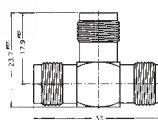

20612260
t-liitin po/2xjatko

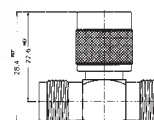

0502200K
runko mutterikiinnitys

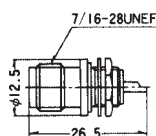

066351022
runko mutterikiinnitys
T6351B1-ND3G-50

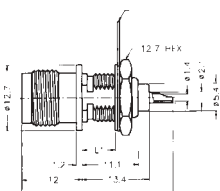

066551032
runko kiinnitys 4 pultilla
T6551A1-001-NT3G-50

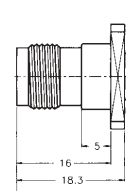
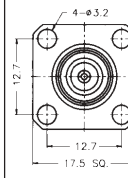

LIITTIMET

N

Amphenol-Kai Jack N liittimet ovat ruuvikiinnitteisiä täysin yhteen sopivia MIL - C - 39012 standardin N-liittimien kanssa. Ne on suunniteltu käyttöön missä tarvitaan hyviä taajuusarvoja 0-11 GHz ja hyvä mekaaninen kestävyys.

Impedanssi	50 ohm, nimellinen
Taajuusalue	0-11 GHz
Jännitteen nimellisarvo	1500 V huippu
Dielektrinen kestävyys, jännite	2500 V rms
VSWR	1.3 max. 0 - 11 GHz
Kontaktivastus	Keskikontakti: 1.0 mohm Ulkokontakti: 0.2 mohm
Eristysvastus	5000 Mohm (min)

0200240

N pistoke RG58 mutteri

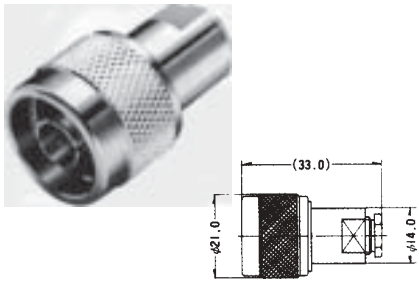

0200272K

N pistoke RG213 mutteri

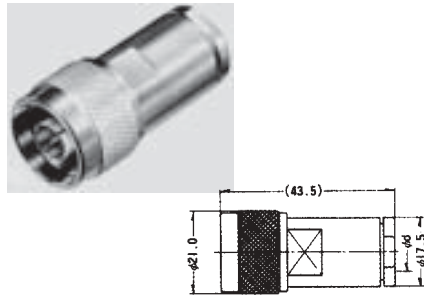

0200284

N pistoke kulma mutteri RG 8,213

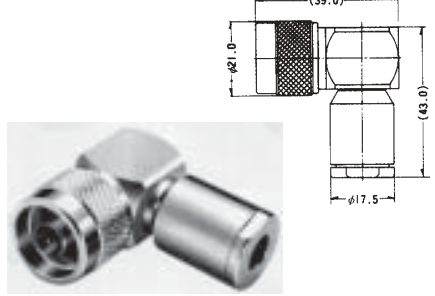

3013058

N pistoke puristettava RG58lle N1121A1

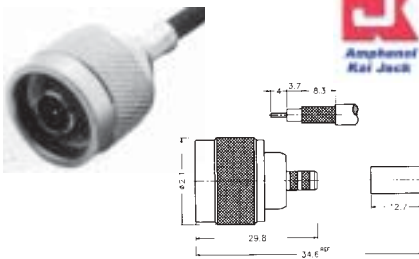

3013213

N pistoke RG213 puristettava

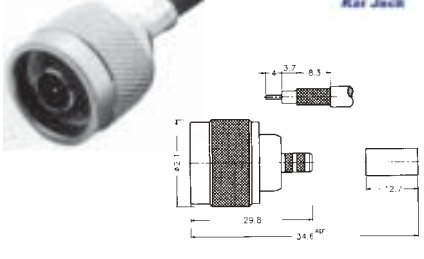

3011213

N pistoke RG213 mutteri N1141A2

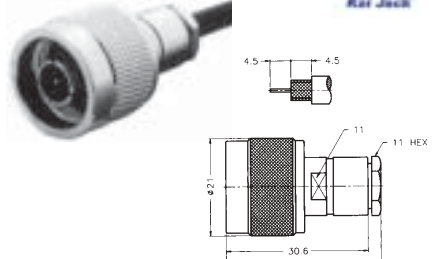

0200400

N jatko puristettava RG 58

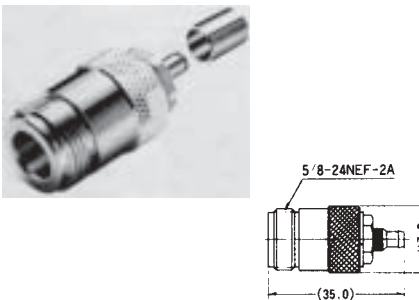

3023213

N jatko RG213 puristettava

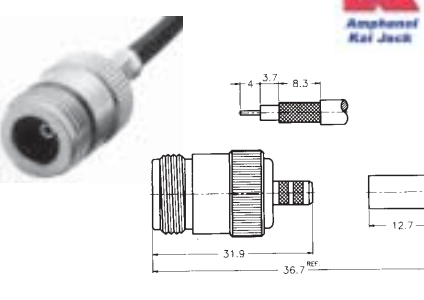

3043058

N jatkorunko puristettava RG58

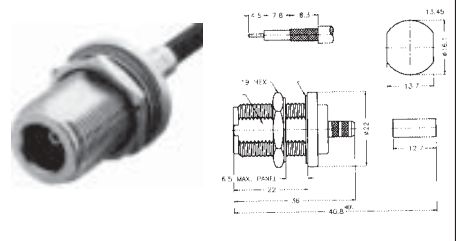

0200292

N runko UG58A/U

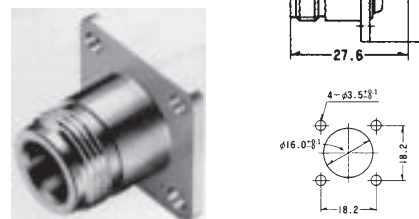

0200300

N runko

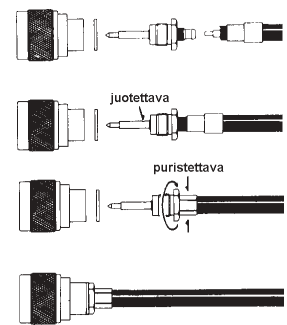
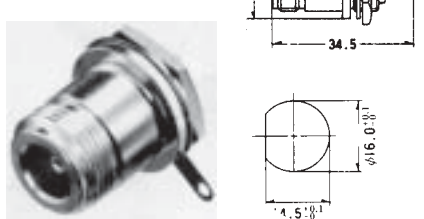

LIITTIMET

N adapterit ja Twin liittimet

2031103
jatko pistoke pistoke

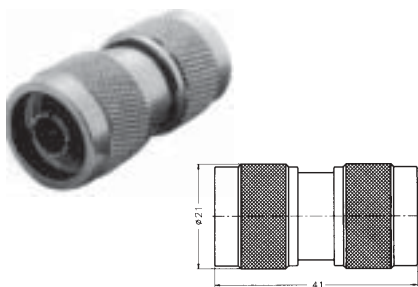

2032203
jatko jatko jatko

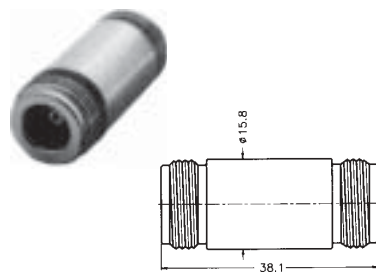

2031210
kulma adapteri

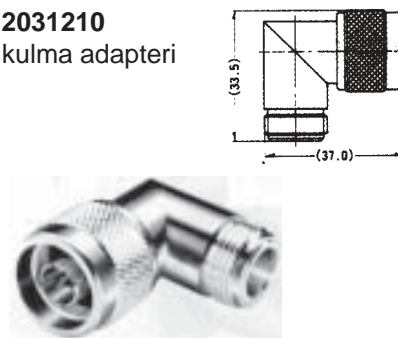

20312260
T haaroitus 2xjatko pistoke

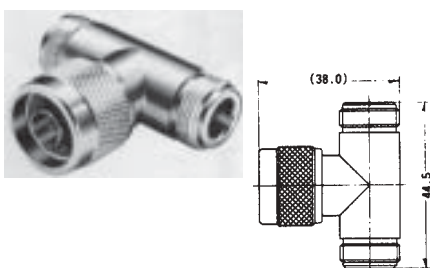

LIITTIMET Twin

Twin-liittimissä käytetään Twinax-kaapelia (RG22 ym).
Niitä käytetään useimmiten atk- verkoissa

Standardi	MIL-C-3655
Jännite	AC 500V
Koestusjännite	AC 1 500V minuutti
Eristysvastus	1 000 MW min DC 500V:ssa
Kontaktivastus	4mW maksimi DC1A:ssa
Taajuusalue	0 - 200MHz
Impedanssi	95 ohm

0220211
TWIN pistoke

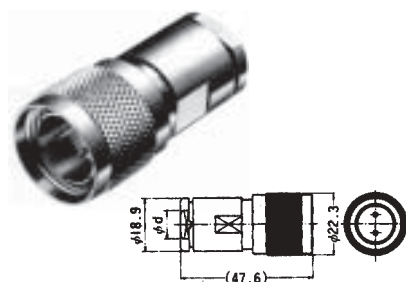

0223271
TWIN runko mutterikiinnitys

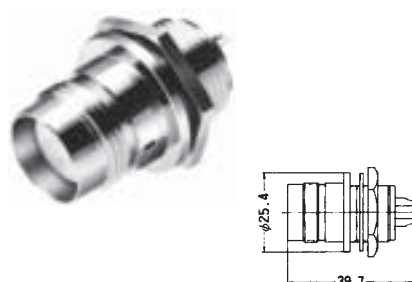

0225271
TWIN runko jatko jatko/jatko

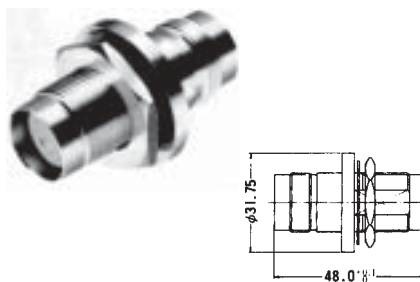

0227203
TWIN T haaroitin pistoke/2jatko



2132203
TWIN jatko jatko/jatko



LIITTIMET

UHF

Standardit: MIL-C-39012, JIS-C-5419
 Nimellisjännite: AC 500V
 Koestusjännite: AC 1000V/min.
 Eritysvastus: 100 MW min DC 500V
 Kontaktivastus: 3 mW max DC 1A
 Liitin: M-tyyppi M 16 x P1
 UHF-tyyppi 5/8-24NEF-2A, 2B

1013058
 pistoke puristettava RG58
 U1121A1



20503213 KJ
 pistoke puristettava RG213



0100014
 pistoke RG58 bakeliitti

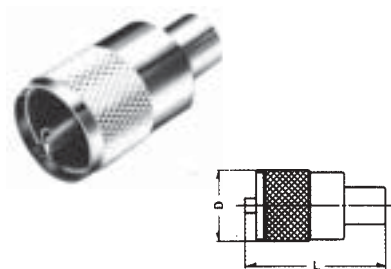

20505
 pistoke Delrin RG213



1011213
 pistoke RG213 PL259 juotettava
 U1181C1

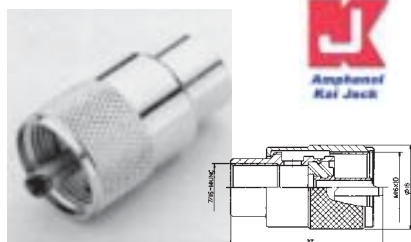

0100030 RG58
0100031 RG59
 supistaja (0100010, 1011213)



0100010K
0100010H hopeoitu
 pistoke RG213,58 supistimella

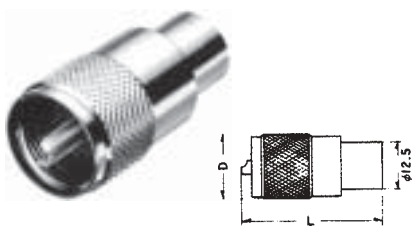

0100078
 pistoke kulma RG58

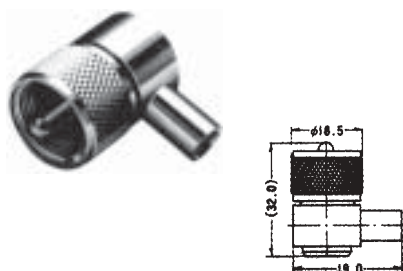

0100062
 runko mutteri bakeliitti
 asennus takaa



20507
 runko mutteri Delrin

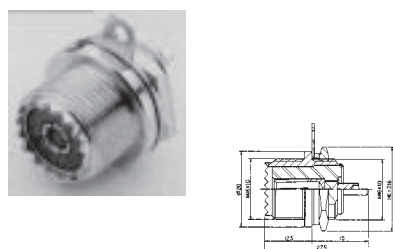

LIITTIMET

F liittimet

0300900
pistoke puristettava RG58

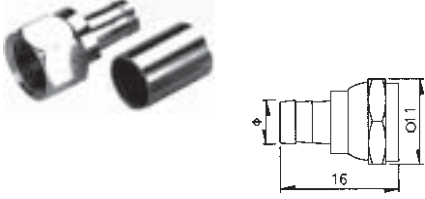

0300911
pistoke puristettava RG59

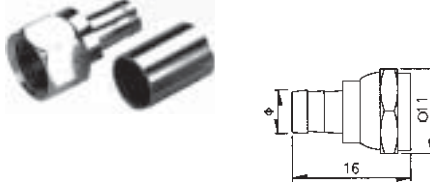

0307206C taivutussuojalla
0307206 ilman suojaa
pistoke puristettava 6,5-7,2 mm Ø
kaapelille

pihti HT336C
Rennsteig leuat 6241363



DV50
pistoke MK79/MK75/MT75, WISI



DV55
pistoke MK90/MK95/MK99, WISI



DV54 WISI
0304111
pistoke MK16/



20606B RG58
20606C RG59
20606D RG6, MK95, MK60
20606E RG213, MK16
pistoke kierrettävä

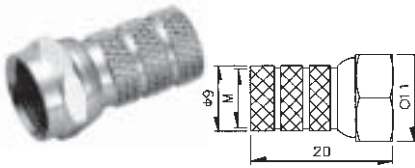

DV49
adapteri pistoke/pistoke pika WISI



DV46
jatko jatko/jatko WISI



DV53
jatkukulma jatko/pistoke WISI



2043203
adapteri jatko/pistoke pika



2041103
adapteri pistoke/pistoke



2041223
jatkukulma-adapteri pistoke/jatko



2042243
jatko jatko/ jatko läpivienti



2042243
jatko jatko/jatko



DV24 wisi
20627
pääte 75 ohm



DV25
pääte DC
erotettu 75 ohm



0300930
asennusreikä



LIITTIMET

RFC, NINEX, FME, CAR

20867 RG58
20867174 RG174
20867L RG58 LOW LOSS
 RFC pistoke puristettava RG58

20867P
 20867 piikki



20869
 RFC runko



8013058
 RFC pistoke puristettava RG58
 FME6121B1



8013174
 RFC pistoke puristettava RG174
 FME6121E1



2082201
 RFC jatko pistoke/pistoke
 FME2071A2



8023058
 RFC jatko puristettava RG58
 FME1121A3



8023174
 RFC jatko puristettava RG174
 FME1121A4



20866 RG58
20866174 RG174
20866L RG58 LOW LOSS
 RFC jatko puristettava

